



# Inspired by temperature

Betriebsanleitung · Operation manual · Manual de instrucciones · Manuel d'utilisation · Manuale de d'uso · 사용 설명서 · Manual de instruções · Инструкция по эксплуатации · Kullanım talimatı · 操作说明书 · Betriebsanweisung · Manual de instrucciones · Manuel d'utilisation · Manuale de d'uso · 사용 설명서 · Manual de instruções · Инструкция по эксплуатации · Kullanım talimatı · 操作说明书 · Betriebsanweisung · Manual de instrucciones · Manuel d'utilisation · Manuale de d'uso · 사용 설명서 · Manual de instruções · Инструкция по эксплуатации · Kullanım talimatı · 操作说明书

## **KISS® Immersion Circulator**

**This documentation does not contain a device-specific technical appendix.**

You can request the full operating instructions from [info@huber-online.com](mailto:info@huber-online.com). Please give the model designation and serial number of your temperature control unit in your e-mail.

# huber





OPERATION MANUAL

**KISS<sup>®</sup>**  
**Immersion Circulator**



# Immersion circulator

KISS®

This operation manual is a translation of the original operation manual.

## VALID FOR:

KISS® E  
KISS® 1xx  
KISS® 2xx

Abbreviations used in model names:

A = polycarbonate bath, B = stainless steel bath, BX = telescope arm, C = cooling coil

The control panel:  
Displays and keys

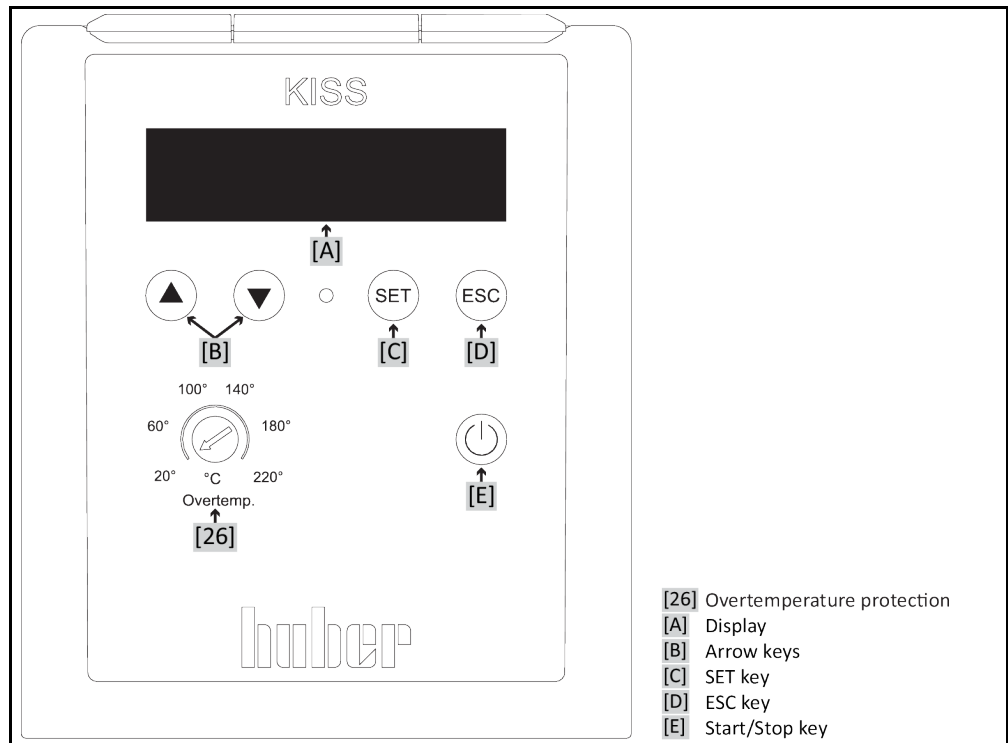

# Table of contents

V1.3.0en/31.08.21//0.3.1

<b>1</b>	<b>Introduction</b>	<b>12</b>
<b>1.1</b>	<b>Identification / symbols in the operation manual</b>	<b>12</b>
<b>1.2</b>	<b>Information on the EU Declaration of Conformity</b>	<b>12</b>
<b>1.3</b>	<b>Safety</b>	<b>12</b>
1.3.1	Symbols used for Safety Instructions	12
1.3.2	Representation of safety identifiers on the temperature control unit	13
1.3.3	Proper operation	13
1.3.4	Reasonably foreseeable misuse	14
<b>1.4</b>	<b>Responsible bodies and operators – Obligations and requirements</b>	<b>15</b>
1.4.1	Obligations of the responsible body	15
1.4.1.1	Proper disposal of resources and consumables	15
1.4.2	Requirements for operators	15
1.4.3	Obligations of the operators	16
<b>1.5</b>	<b>General information</b>	<b>16</b>
1.5.1	Description of workstation	16
1.5.2	Safety devices to DIN 12876	16
1.5.3	Further protective devices	17
1.5.3.1	Power interruption	17
<b>2</b>	<b>Commissioning</b>	<b>18</b>
<b>2.1</b>	<b>In-plant transport</b>	<b>18</b>
2.1.1	Lifting and transporting the temperature control unit	18
2.1.1.1	Temperature control unit with lifting eyes	18
2.1.1.2	Temperature control unit without lifting eyes	19
2.1.2	Mounting/removing leveling feet	19
2.1.3	Positioning the temperature control unit	20
2.1.3.1	Temperature control unit with casters	20
2.1.3.2	Temperature control unit without casters	20
<b>2.2</b>	<b>Unpacking</b>	<b>20</b>
<b>2.3</b>	<b>Ambient conditions</b>	<b>20</b>
2.3.1	EMC-specific notes	22
<b>2.4</b>	<b>Installation conditions</b>	<b>22</b>
<b>2.5</b>	<b>Recommended temperature control and cooling water hoses</b>	<b>22</b>
<b>2.6</b>	<b>Wrench sizes and torques</b>	<b>23</b>
<b>2.7</b>	<b>Temperature control units with cooler</b>	<b>23</b>
<b>2.8</b>	<b>Temperature control unit with batch</b>	<b>25</b>
2.8.1	Operation as bath thermostat	25
<b>2.9</b>	<b>Preparations for operation</b>	<b>25</b>
2.9.1	Unscrewing/activating the leveling feet (if any)	25
2.9.2	Externally closed and externally open applications	25
2.9.3	Installing collecting container	26
2.9.4	Connecting the functional earth	26
<b>2.10</b>	<b>Connecting externally closed application</b>	<b>26</b>
2.10.1	Connecting an externally closed application	26
<b>2.11</b>	<b>Connecting to the power supply</b>	<b>27</b>
2.11.1	Connection using socket with protective earth (PE)	27
2.11.2	Connection via hard wiring	27

<b>3</b>	<b>Function description</b>	<b>28</b>
<b>3.1</b>	<b>Function description of the temperature control unit</b>	<b>28</b>
3.1.1	General functions	28
3.1.2	Other functions	28
<b>3.2</b>	<b>Information on the thermal fluids</b>	<b>28</b>
<b>3.3</b>	<b>To be noted when planning the test</b>	<b>29</b>
<b>3.4</b>	<b>Display and control instruments</b>	<b>30</b>
3.4.1	Display	30
3.4.2	Control instruments	31
3.4.2.1	Arrow keys	31
3.4.2.2	SET key	31
3.4.2.3	ESC key	31
3.4.2.4	Start/Stop key	32
3.4.3	Adjusting settings	32
<b>3.5</b>	<b>Menu function</b>	<b>33</b>
<b>3.6</b>	<b>Functional examples</b>	<b>34</b>
3.6.1	Selecting a language	34
3.6.2	Setting the setpoint	34
3.6.3	Changing the Auto-Start function	34
<b>4</b>	<b>Setup mode</b>	<b>35</b>
<b>4.1</b>	<b>Setup mode</b>	<b>35</b>
4.1.1	Turning on the temperature control unit	35
4.1.2	Turning off the temperature control unit	35
4.1.3	Setting the overtemperature (OT) protection	35
4.1.3.1	General information on the overtemperature protection	35
4.1.3.2	Setting the overtemperature protection	36
4.1.4	Testing overtemperature protection for functionality	36
<b>4.2</b>	<b>Filling, venting, degassing and draining</b>	<b>37</b>
4.2.1	Filling, venting, degassing and draining the bath thermostat	37
4.2.1.1	Filling and venting the bath thermostat and the externally closed application	37
4.2.1.2	Degassing of bath thermostat	38
4.2.1.3	Draining the bath thermostat	38
<b>5</b>	<b>Normal operation</b>	<b>40</b>
<b>5.1</b>	<b>Automatic operation</b>	<b>40</b>
5.1.1	Temperature control	40
5.1.1.1	Starting the temperature control process	40
5.1.1.2	Ending the temperature control process	40
<b>6</b>	<b>Interfaces and data communication</b>	<b>41</b>
<b>6.1</b>	<b>Controller interfaces</b>	<b>41</b>
6.1.1	USB-2.0 interface	41
6.1.1.1	USB-2.0 interface, device	41
6.1.2	RS232 jack	41
6.1.3	Pt100 process display sensor port (option)	42
<b>6.2</b>	<b>Interfaces on the temperature control unit</b>	<b>42</b>
6.2.1	Interfaces at the back	42
6.2.1.1	RS232 jack	42
<b>6.3</b>	<b>Data communication</b>	<b>43</b>
6.3.1	LAI commands	43
6.3.1.1	Command "V" (Verify)	44



6.3.1.2	Command "L" (Limit) .....	44
6.3.1.3	Command "G" (General) .....	45
6.3.2	PP commands.....	46
<b>7</b>	<b>Service/maintenance</b> .....	<b>48</b>
<b>7.1</b>	<b>Displays in the event of faults</b> .....	<b>48</b>
<b>7.2</b>	<b>Electrical fuse</b> .....	<b>49</b>
<b>7.3</b>	<b>Maintenance</b> .....	<b>49</b>
7.3.1	Function check and visual inspection .....	49
7.3.2	Replacing temperature control or coolant hoses .....	50
7.3.2.1	Replacing temperature control hoses .....	50
7.3.2.2	Replacing coolant hoses .....	50
<b>7.4</b>	<b>Thermal fluid inspection, replacement and circuit cleaning</b> .....	<b>51</b>
7.4.1	Thermal fluid inspection .....	51
7.4.2	Rinsing the thermal fluid circuit.....	51
<b>7.5</b>	<b>Cleaning the surfaces</b> .....	<b>53</b>
<b>7.6</b>	<b>Plug contacts</b> .....	<b>53</b>
<b>7.7</b>	<b>Decontamination/repairs</b> .....	<b>53</b>
<b>8</b>	<b>Shutting down</b> .....	<b>54</b>
<b>8.1</b>	<b>Safety instructions and basic principles</b> .....	<b>54</b>
<b>8.2</b>	<b>Switch-off</b> .....	<b>54</b>
<b>8.3</b>	<b>Draining the temperature control unit</b> .....	<b>55</b>
<b>8.4</b>	<b>Draining the cooling water</b> .....	<b>55</b>
8.4.1	Draining process .....	55
<b>8.5</b>	<b>Deinstalling the collecting container</b> .....	<b>55</b>
<b>8.6</b>	<b>Uninstalling an external application</b> .....	<b>55</b>
<b>8.7</b>	<b>Packing</b> .....	<b>55</b>
<b>8.8</b>	<b>Shipping</b> .....	<b>56</b>
<b>8.9</b>	<b>Disposal</b> .....	<b>56</b>
<b>8.10</b>	<b>Contact data</b> .....	<b>57</b>
8.10.1	Telephone number: Customer Support .....	57
8.10.2	Telephone number: Sales .....	57
8.10.3	Email address: Customer Support.....	57
<b>8.11</b>	<b>Certificate of Compliance</b> .....	<b>57</b>
<b>9</b>	<b>Annex</b> .....	<b>58</b>



## Foreword

Dear Customer,

Thank you for choosing a temperature control unit from Peter Huber Kältemaschinenbau SE. You have made a good choice. Thank you for your trust.

Please read the operation manual carefully before putting the unit into operation. Strictly follow all notes and safety instructions.

Follow the operation manual with regard to transport, start-up, operation, maintenance, repair, storage and disposal of the temperature control unit.

We fully warrant the temperature control unit for the specified intended operation.

The models listed on page 5 are referred to in this operation manual as temperature control units and Peter Huber Kältemaschinenbau SE as Huber company or Huber.

Liability for errors and misprints excluded.

The following trademarks and the Huber logo are registered trademarks of Peter Huber Kältemaschinenbau SE in Germany and/or other countries worldwide: BFT®, CC®, Chili®, Com.G@te®, Compatible Control®, CoolNet®, DC®, E-grade®, Grande Fleur®, Huber Piccolo®, KISS®, Minichiller®, Ministat®, MP®, MPC®, Peter Huber Minichiller®, Petite Fleur®, Pilot ONE®, RotaCool®, Rotostat®, SpyControl®, SpyLight®, Tango®, TC®, UC®, Unical®, Unichiller®, Unimotive®, Unipump®, Unistat®, Unistat Tango®, Variostat®. The following trademarks are registered in Germany to DWS Synthesetechnik: DW-Therm®, DW-Therm HT®. The following trademark is a registered trademark of BASF SE: Glystantin®.

# 1 Introduction

## 1.1 Identification / symbols in the operation manual

The following identifications and symbols are used in the texts and illustrations.

Overview	Identification / symbol	Description
	→	Reference to information / procedure.
	»TEXT«	Reference to a chapter in the operation manual. In the digital version, the text is clickable.
	>TEXT< [NUMBER]	Reference to the wiring diagram in the annex. The designation and the search digit are specified.
	>TEXT< [LETTER]	Reference to a drawing in the same paragraph. The designation and the search digit are specified.
	▪	List, first level
	–	List, second level

## 1.2 Information on the EU Declaration of Conformity



The equipment complies with the basic health and safety requirements of the European Directives listed below:

- Machinery Directive
- Low Voltage Directive
- EMC Directive

## 1.3 Safety

### 1.3.1 Symbols used for Safety Instructions

Safety instructions are marked by the below combinations of pictograms and signal words. The signal word describes the classification of the residual risk when disregarding the operation manual.



Denotes an immediate hazardous situation that will result in death or serious injuries.



Denotes a general hazardous situation that may result in death or serious injuries.



Denotes a hazardous situation that can result in injury.



Denotes a situation that can result in property material damage.



Denotes important notes and usable hints.



Notes in conjunction with Ex px cabinets.

Safety information and procedure

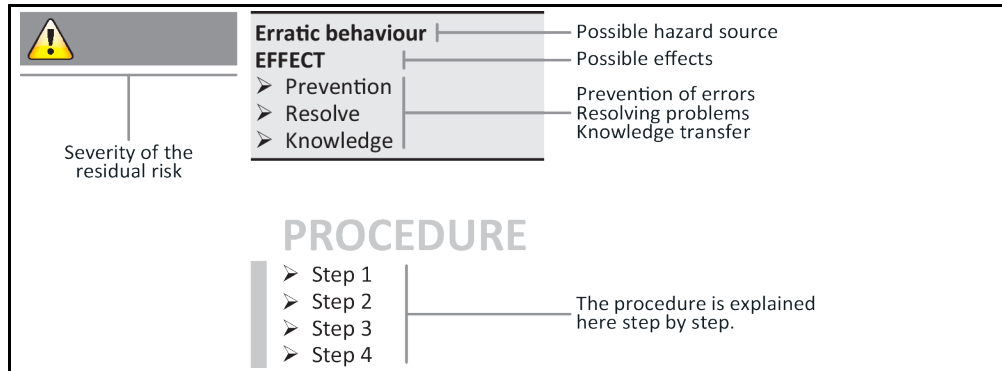

The safety information in this operation manual is designed to protect the operating company, the operator and the equipment from damage. First inform yourself about any residual risks due to misuse before you start an operation.

### 1.3.2 Representation of safety identifiers on the temperature control unit

The following pictograms are used as safety identifiers. The table gives an overview of the safety identifiers used here.

Identifier	Description
<b>Mandatory sign</b>	
	- Observe the instructions
<b>Warning sign</b>	
	- General warning sign - Observe the instructions
	- Warning of electrical voltage
	- Warning of hot surface
	- Warning of flammable substances

### 1.3.3 Proper operation



**Operating the temperature control unit in a potentially explosive area**

**DEATH THROUGH EXPLOSION**

- Do NOT install or start up the temperature control unit within an ATEX zone.

 **WARNING**

**Improper use**

**SERIOUS INJURY AND PROPERTY DAMAGE**

- Store the operation manual where it is easy to access in close proximity to the temperature control unit.
- Only adequately qualified operators may work with the temperature control unit.
- Operators must be trained before handling the temperature control unit.
- Check that the operators have read and understood the operation manual.
- Define precise responsibilities of the operators.
- Personal protective equipment must be provided to the operators.
- Be sure to follow the responsible body's safety rules to protect life and limb and to limit damages!

**NOTE**

**Modifications to the temperature control unit by third-parties**

**DAMAGE TO THE TEMPERATURE CONTROL UNIT**

- Do not allow third parties to make technical modifications to the temperature control unit.
- The EU declaration of conformity becomes invalid if any modifications are made to the temperature control unit without the approval of Huber.
- Only specialists trained by Huber may carry out modifications, repairs or maintenance work.
- **The following must be observed without fail:**
- Only use the temperature control unit in a fault-free condition!
- Have the start-up and repairs carried out by specialists only!
- Do not ignore, bypass, dismantle or disconnect any safety devices!

The temperature control unit must not be used for any purposes other than temperature control in accordance with the operation manual.

The temperature control unit is made for industrial use. The temperature control unit is used to maintain the temperature of applications, such as glass or metal reactors or other expedient items in laboratories and industry. Flow-through coolers and calibration baths must be used only in combination with Huber temperature control units. Only use thermal fluids suitable for the overall system. The cooling or heating capacity is provided at the pump connections or - where present - in the tempering bath. For the technical specification, refer to the datasheet. → From page 58, section »Annex«. Install, set up and operate the temperature control unit according to the instructions in this operation manual. Any failure to comply with the operation manual is considered as improper operation. The temperature control unit was manufactured according to the state of the art and the recognized safety rules and regulations. Safety devices are installed in your temperature control unit.

1.3.4 Reasonably foreseeable misuse



Without an Ex px cabinet, the temperature control unit / accessory is **NOT** protected against explosion and must **NOT** be installed or put into operation within an ATEX Zone. When operating the temperature control unit /accessory in conjunction with an Ex px cabinet, the information in the annex (Section ATEX operation) must be observed and followed. This annex is only provided for temperature control units /accessories delivered with an Ex px cabinet. If this annex is missing, please immediately contact the Customer Support. → Page 57, section »Contact data«.

Use with medical devices (e.g. in Vitro diagnostic procedure) or for direct foodstuff temperature control is **NOT** permissible.

The temperature control unit must **NOT** be used for any purposes other than temperature control in accordance with the operation manual.

The manufacturer accepts **NO** liability for damage caused by **technical modifications** to the temperature control unit, **improper handling** or use of the temperature control unit if the operation manual is **not observed**.

## 1.4 Responsible bodies and operators – Obligations and requirements

### 1.4.1 Obligations of the responsible body

The operation manual is to be stored where it is easy to access in close proximity to the temperature control unit. Only adequately qualified operators (e.g. chemists, CTA, physicists etc.) are permitted to work with the temperature control unit. Operators must be trained before handling the temperature control unit. Check that the operators have read and understood the operation manual. Define precise responsibilities of the operators. Personal protective equipment must be provided to the operators.

- The responsible body must install a condensation water / thermal fluid drip tray below the temperature control unit.
- The use of a drip tray may be prescribed by national legislation for the installation area of the temperature control unit (incl. accessory). The responsible body must check and apply the national regulations applicable for it accordingly.
- The temperature control unit complies with all applicable safety standards.
- Your system, which uses our temperature control unit, must be equally safe.
- The responsible body must design the system to ensure it is safe.
- Huber is not responsible for the safety of your system. The responsible body is responsible for the safety of the system.
- Although the temperature control unit provided by Huber meets all the applicable safety standards, integration into a system may give rise to hazards that are characteristic of the other system's design and beyond the control of Huber.
- It is the responsibility of the system integrator to ensure that the overall system, into which this temperature control unit is integrated, is safe.
- The **>Mains isolator<** [36] (if present) can be locked in the off position to facilitate safe system installation and maintenance of the temperature control unit. It is the responsibility of the responsible body to develop any lock-out/tag-out procedure for the energy source in accordance with local regulations (e.g. CFR 1910.147 for the US).

#### 1.4.1.1 Proper disposal of resources and consumables

Do comply with all national disposal regulations applicable for you. Contact your local waste management company for any questions concerning disposal.

Overview	Material / Aids	Disposal / Cleaning
	Packaging material	Keep the packaging material for future use (e.g. transport).
	Thermal fluid	Please refer to the safety data sheet of the thermal fluid used for information on its proper disposal. Use the original thermal fluid container when disposing it.
	Filling accessories, e.g. beaker	Clean the filling accessories for reuse. Make sure that the materials and cleaning agents used are properly disposed of.
	Aids such as towels, cleaning cloths	Tools used to take up spilled thermal fluid must be disposed of in the same fashion as the thermal fluid itself. Tools used for cleaning must be disposed of depending on the cleaning agent used.
	Cleaning agents such as stainless steel cleaning agents, sensitive-fabrics detergents	Please refer to the safety data sheet of the cleaning agent used for information on its proper disposal. Use the original containers when disposing of large quantities of cleaning agents.
	Consumables such as air filter mats, temperature control hoses	Please refer to the safety data sheet of the consumables used for information on their proper disposal.

### 1.4.2 Requirements for operators

Work on the temperature control unit is reserved for appropriately qualified specialists, who have been assigned and trained by the responsible body to do so. Operators must be at least 18 years old. Under 18-year olds may operate the temperature control unit only under the supervision of a qualified specialist. The operator is responsible vis-a-vis third-parties in the work area.

### 1.4.3 Obligations of the operators

Carefully read the operation manual before operating the temperature control unit. Please observe the safety instructions. When operating the temperature control unit, wear appropriate personal protective equipment (e.g. safety goggles, protective gloves, non-slip shoes).

## 1.5 General information

### 1.5.1 Description of workstation

The workstation is located at the control panel in front of the temperature control unit. The workstation is determined by the customer's connected peripheries. Accordingly, it must be designed safe by the responsible body. The workstation design also depends on the applicable requirements of the German occupational health and safety regulations [BetrSichV] and the risk analysis for the workstation.

### 1.5.2 Safety devices to DIN 12876

The rating of your temperature control unit is stated on the data sheet in the appendix.

Rating of laboratory thermostats and laboratory baths	Classification	Temperature control medium	Technical requirements	Identification <sup>d)</sup>
	I	Non-combustible <sup>a)</sup>	Overheat protection <sup>c)</sup>	NFL
	II	Combustible <sup>b)</sup>	Adjustable overheat protection	FL
	III	Combustible <sup>b)</sup>	Adjustable overtemperature protection and additional low-level protection	FL

<sup>a)</sup> Usually water; other fluids only if non-combustible even within the temperature range of an individual fault.  
<sup>b)</sup> The temperature control media must have a fire point of  $\geq 65$  °C.  
<sup>c)</sup> The overheat protection can, for instance, be realized using a suitable fill level sensor or a suitable temperature limiter.  
<sup>d)</sup> Optional at the choice of the manufacturer.

Overview of the temperature thresholds

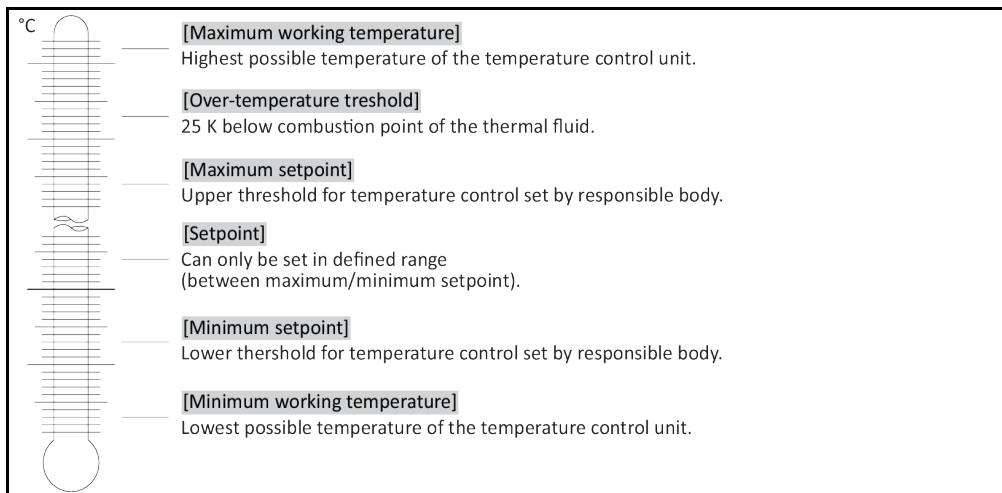

#### Mechanical overtemperature protection

Only temperature control units with a heater are fitted with a mechanical overtemperature protection. → Page 35, section »Setting the overtemperature (OT) protection«.

#### Low level protection

A mechanical float is used for level monitoring. In the bath vessel, a floating body, which is guided in a device, floats on the surface of the thermal fluid. Depending on the level of the thermal fluid, the float device signals the electronics a **state of good** (in case of sufficient filling) or a **state of bad** (in case of insufficient filling). The functionality of the float switch is checked at regular intervals during continuous operation.



### 1.5.3 Further protective devices

**INFORMATION**

Emergency strategy – interrupt the power grid connection!

To determine the type of switch or switch combination your temperature control unit is equipped with, please refer to the wiring diagram. → From page 58, section »Annex«.

**Temperature control units with >Mains isolator< [36] (red/yellow or gray):** Turn the >Mains isolator< [36] to the "0" position.

**Temperature control units with >Mains isolator< [36] (red/yellow) and additional >Appliance switch< [37] (gray):** Turn the >Mains isolator< [36] to the "0" position. Then turn the >Appliance switch< [37] to the "0" position!

**Temperature control units with >Mains isolator< [36] (gray) and >Emergency stop switch< [70] (red/yellow):** Press the >Emergency stop switch< [70]. Then turn the >Main switch< [36] to the "0" position!

**Temperature control units with >Mains switch< [37]:** Power supply via socket: Disconnect the temperature control unit from the power supply. Then turn the >Mains isolator< [37] to the "0" position! Power supply via hard wiring: Disconnect the power grid supply by means of the building's circuit breaker. Then turn the >Mains isolator< [37] to the "0" position!

**Temperature control units without a switch or inside a protective housing:** Connection via socket: Disconnect the temperature control unit from the power supply. Connection via hard wiring: Disconnect the power grid supply by means of the building's circuit breaker!

#### 1.5.3.1 Power interruption

Following a power outage (or when switching on the temperature control unit), this function can be used to determine how the temperature control unit is supposed to respond.

**Auto start function switched off**

The temperature control is started only by manual input when the temperature control unit is turned on.

**Auto start function switched on**

The temperature control unit is set to the same state it was in before the power outage. For example, before the power outage: Temperature control is off; after power outage: Temperature control is off. If temperature control was active during a power outage, the process will automatically continue after the power outage.

→ Page 34, section »Changing the Auto-Start function«.

## 2 Commissioning

### 2.1 In-plant transport

**WARNING**

Temperature control unit is not transported / moved according to the specifications in this operation manual

**DEATH OR SERIOUS INJURY DUE TO CRUSHING**

- Always transport / move the temperature control unit according to the specifications in this operation manual.
- Wear personal protective equipment during transport.
- Always work with the specified number of persons when moving the temperature control unit on casters (if any).
- If the temperature control unit is equipped with casters and parking brakes: 2 parking brakes are always freely accessible when moving the temperature control unit. Activate the **2 parking brakes** in an emergency! If only **one** parking brake is activated on the casters in an emergency: The temperature control unit is not stopped but rotates around the axis of the caster with the activated parking brake!

**NOTE**

Temperature control unit transported in a horizontal position

**DAMAGE TO THE COMPRESSOR**

- Only transport the temperature control unit in an upright position.

**NOTE**

Filled temperature control unit is transported

**MATERIAL DAMAGE DUE TO OVERFLOWING THERMAL FLUID**

- Only transport an emptied temperature control unit.
- If available, use the lugs on the top side of the temperature control unit for transportation.
- Use an industrial truck for transport.
- The casters (if present) on the temperature control unit are not suitable for transport. The casters are symmetrically loaded with 25% of the total mass of the temperature control unit.
- Remove the packing material (e.g. the palette) only at the place of installation.
- Protect the temperature control unit from transport damage.
- Do not transport the temperature control unit alone and without aids.
- Check the load bearing capacity of the transportation route and the place of installation.
- The parking brakes at the casters (if any) must be activated and/or the leveling feet (if any) must be unscrewed/activated before the temperature control unit is put into operation. → Page 25, section »Unscrewing/activating the leveling feet (if any)«.

#### 2.1.1 Lifting and transporting the temperature control unit

##### 2.1.1.1 Temperature control unit with lifting eyes

**NOTE**

The temperature control unit is raised at the lifting eyes without load handling attachments

**DAMAGE TO THE TEMPERATURE CONTROL UNIT**

- Always use load handling attachments when lifting and transporting the temperature control unit.
- The lifting eyes are only designed for a load **without** inclination (0°).
- The load handling attachment used must be adequately dimensioned. Take the dimensions and weight of the temperature control unit into account.

Example: lifting eyes (round, angular, and recessed (left to right))

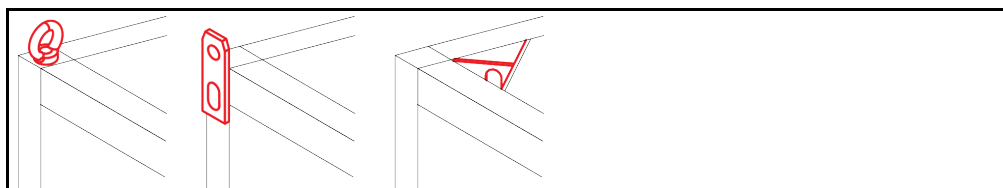

- Do not lift and transport the temperature control unit at the lifting eyes alone and without aids.
- Lift and transport the temperature control unit at the lifting eyes only with a crane or an industrial truck.
- The crane or industrial truck must have a lifting force equal to or greater than the weight of the temperature control unit. See the data sheet for the weight of the temperature control unit. → From page 58, section »Annex«.
- If the leveling feet have been removed for shipping: Only lower the temperature control unit when all leveling feet have been installed. → Page 19, section »Mounting/removing leveling feet«.

**2.1.1.2 Temperature control unit without lifting eyes**

Example: Supporting points for forklift arms for free-standing models from a certain overall size. For the exact position please refer to the wiring diagram in the annex.

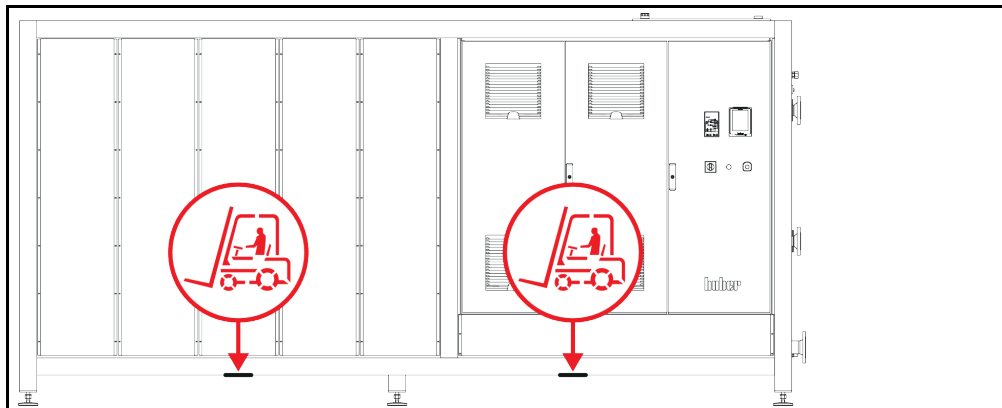

- Do not lift and transport the temperature control unit alone and without aids.
- Lift and transport the temperature control unit only with an industrial truck.
- The industrial truck must have a lifting force equal to or greater than the weight of the temperature control unit. See the data sheet for the weight of the temperature control unit. → From page 58, section »Annex«.
- If the leveling feet have been removed for shipping: Only lower the temperature control unit when all leveling feet have been installed. → Page 19, section »Mounting/removing leveling feet«.

**2.1.2 Mounting/removing leveling feet**

Only valid if the leveling feet have been removed for shipping.



**WARNING**

**The temperature control unit is not secured against slipping and/or lowering  
DEATH OR SERIOUS INJURY DUE TO CRUSHING**

- Secure the temperature control unit against slipping and/or lowering before the leveling feet are mounted.
- Do not stand or lie under the temperature control unit for mounting.

Example: mounting the leveling feet

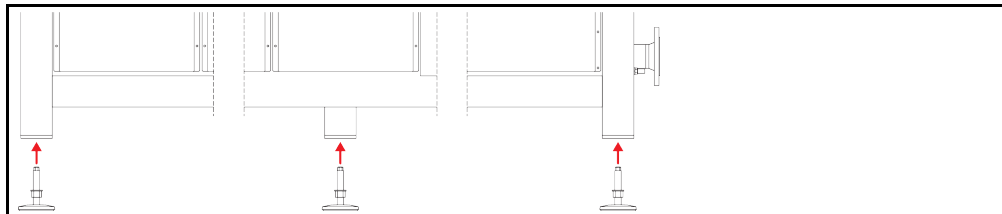

**INFORMATION**

The leveling feet were removed for shipping the temperature control unit. Before placing / positioning the temperature control unit all leveling feet must be mounted. If the temperature control unit is re-shipped: Remove all leveling feet before packaging.

- The leveling feet can only be mounted while the temperature control unit is lifted.
- Secure the temperature control unit against slipping and/or lowering.
- Do not stand or lie under the temperature control unit while mounting the leveling feet.
- Do not lower the temperature control unit until all leveling feet have been mounted.

## 2.1.3 Positioning the temperature control unit

### 2.1.3.1 Temperature control unit with casters

- Do **not** use the casters for the transportation to the place of installation. → Page 18, section »**Lifting and transporting the temperature control unit**«.
- Use the casters only for positioning at the place of installation.
- Only ever move the temperature control unit on the casters if the surface is level, without gradient, non-slip and stable.
- Do not move the temperature control unit alone.
- **At least 2 persons** are required to move the temperature control unit on casters. **At least 5 persons** are required to move the temperature control unit on the casters if the total weight of the temperature control unit is **over 1.5 tons**.
- The parking brakes must be activated at the casters and/or the feet (if present) must be unscrewed/activated before the temperature control unit is put into operation. → Page 25, section »**Unscrewing/activating the leveling feet (if any)**«.

### 2.1.3.2 Temperature control unit without casters

- An industrial truck must be used for positioning the temperature control unit.
- Do not move the temperature control unit alone.
- **At least 2 persons** are required to move the temperature control unit.
- The industrial truck must have a lifting force equal to or greater than the weight of the temperature control unit. See the data sheet for the weight of the temperature control unit. → From page 58, section »**Annex**«.
- The leveling feet (if present) must be unscrewed/activated before the temperature control unit is put into operation. → Page 25, section »**Unscrewing/activating the leveling feet (if any)**«.

## 2.2 Unpacking



**WARNING**

**Starting up a damaged temperature control unit**

**DANGER TO LIFE FROM ELECTRIC SHOCK**

- Do not operate a damaged temperature control unit.
- Please contact Customer Support. → Page 57, section »**Contact data**«.

## PROCEDURE

- Check for damage to the packaging. Damage can indicate material damage to the temperature control unit.
- Check for any transport damage when unpacking the temperature control unit.
- Always contact your forwarding agent regarding the settlement of claims.
- Observe the proper disposal of packaging material. → Page 15, section »**Proper disposal of resources and consumables**«.

## 2.3 Ambient conditions



**CAUTION**

**Unsuitable ambient conditions / unsuitable installation**

**SERIOUS INJURY DUE TO CRUSHING**

- Comply with all requirements! → Page 20, section »**Ambient conditions**« and → Page 22, section »**Installation conditions**«.

**INFORMATION**

Make sure there is adequate fresh air available at the site for the circulation pump and the compressors. The warm exhaust air must be able to escape upwards unhindered.

**Free-standing models**

For the connection data, see the data sheet. → From page 58, section »**Annex**«.

Use of the temperature control unit is permitted only under normal ambient conditions in accordance with the currently valid DIN EN 61010-1.

- Use only indoors. The illuminance must be at least 300 lx.
- Installation altitude up to 2,000 meters above sea level.
- Maintain wall and ceiling clearance for adequate air exchange (dissipation of waste heat, supply of fresh air for the temperature control unit and work area). Ensure adequate floor clearance for air-cooled temperature control units. Do not operate this temperature control unit from within the box or with an inadequately dimensioned bath. This inhibits the air exchange.
- Ambient temperature values are provided on the technical data sheet; to ensure trouble-free operation, compliance with the ambient conditions is mandatory.
- Relative humidity max 80% to 32 °C and 40 °C decreasing linearly to 50%.
- Short distance to supply connections.
- The temperature control unit must not be installed so as to hinder or even prevent access to the disconnecting device (to the power supply).
- For the magnitude of the mains voltage fluctuations, refer to the datasheet. → From page 58, section »Annex«.
- Transient surges, as would normally occur in the power supply system.
- Installation Class 3
- Applicable degree of soiling: 2.
- Surge category II.

Wall clearances

Distance in cm	
Side	
[A2] Top	can be located under a bench
[B] Left	min. 10
[C] Right	min. 10
[D] Front	min. 10
[E] Rear	min. 10
Distance in cm (for operation in a tub)	
Side	
[A2] Top	can be located under a bench
[B] Left	min. 20
[C] Right	min. 20
[D] Front	min. 20
[E] Rear	min. 20

### 2.3.1 EMC-specific notes

**INFORMATION**

**Connecting cables in general**

Prerequisites for a failure-free operation of the temperature control units incl. their connections with external applications: Installation and wiring must be carried out professionally. Related topics: "Electrical safety" and "EMC-compliant wiring".

**Cable lengths**

For flexible/fixed cable routing of more than 3 meters, the following must amongst other things be observed:

- Equipotential bonding, grounding (see also technical data sheet "Electromagnetic compatibility EMC")
- Compliance with "external" and/or "internal" lightning/overvoltage protection.
- Design protection measures, professional cable selection (UV resistance, steel pipe protection, etc.)

**Attention:**

The operating company is responsible for compliance with national/international directives and laws. This also includes the testing of the installation/wiring required by law or standards.

This device is suitable for operation in "industrial electromagnetic environments". It meets the "immunity requirements" of the currently applicable **EN61326-1**, which are required for this environment.

It also meets the "interference emission requirements" for this environment. It is a **Group 1** and **Class A** device according to the currently applicable **EN55011**.

**Group 1** specifies that high frequency (HF) is only used for the function of the device. **Class A** defines the interference emission limits to be observed.

## 2.4 Installation conditions

**WARNING**

**Temperature control unit is connected to the power supply line**

**DEATH FROM ELECTRICAL SHOCK BY DAMAGE TO THE POWER CABLE.**

- Do not put temperature control unit on power cable.

**CAUTION**

**Operating the temperature control unit fitted with casters without brakes activated**

**CRUSHING OF LIMBS**

- Activate brakes on the casters.

- Allow the temperature control unit to acclimate for about 2 hours when changing from a cold to a warm environment (or vice versa). Do not turn on the temperature control unit before!
- Install upright, stable and tilt-resistant.
- Use a non-combustible, sealed foundation.
- Keep the environment clean: Prevent slip and trip hazards.
- Wheels, if installed, must be locked after installation!
- Spilled/leaked thermal fluid must be removed immediately. Observe the proper disposal of thermal fluid and aids. → Page 15, section »Proper disposal of resources and consumables«.
- Observe the floor load bearing capacity for large units.
- Observe the ambient conditions.

## 2.5 Recommended temperature control and cooling water hoses

**CAUTION**

**Use of unsuitable/defective hoses and/or hose connections**

**INJURIES**

- **Thermal fluid**
- Use appropriate hoses and/or hose connections.
- Check periodically for leaks and the quality of the hose and hose connections and take suitable measures (replace) as required.
- Isolate and protect temperature control hoses against contact/mechanical load.
- **Cooling water**
- Reinforced hoses must be used to satisfy tougher safety requirements.
- Shut off the cooling water supply to the temperature control unit even for shorter downtimes (e.g. overnight).

**CAUTION**

**Hot or cold thermal fluid and surfaces**

**BURNS TO LIMBS**

- Avoid direct contact with the thermal fluids or the surfaces.
- Wear your personnel protective equipment (e.g. temperature-resistant safety gloves, safety goggles, safety footwear).

**CAUTION**

**Uncontrolled formation of ice at the connections and hoses of the thermal fluid circuit**

**SLIP AND TRIP HAZARD**

- If the temperature is controlled in the minus range, ice forms at the hoses and connections of the thermal fluid circuit. This occurs by condensing and freezing of atmospheric humidity.
- Check the strength of the ice formation. If too much ice is formed, this increases the risk of the temperature control unit tipping over. Secure the temperature control unit against tipping if this is the case.
- Check the ground below the ice formation for condensation water. Collect the condensation water with a suitable container or thoroughly remove it at regular intervals. You thus prevent the danger of slipping caused by condensation.

To connect applications, use only temperature control hoses that are compatible with the thermal fluid used. When selecting temperature control hoses, also pay attention to the temperature range in which the hoses are to be used.

- We recommend you use only temperature-insulated temperature control hoses with your temperature control unit. The responsible body is responsible for the insulation of connection valves.
- We **exclusively** recommend reinforced hoses for connecting to the cooling water supply. Cooling water and insulated temperature control hoses can be found in the Huber catalogue under Accessories.

## 2.6 Wrench sizes and torques

Note the wrench sizes that result for the pump connection on the temperature control unit. The following table lists the pump connections and the resulting wrench sizes, and torque values. A leak test must always be performed, and the connections tightened if necessary. The values of the maximum torque (see table) must **not** be exceeded.

Overview  
wrench sizes and  
torques

Connection	Sleeve nut wrench size	Connector wrench size	Recommended torques in Nm	Maximum torques in Nm
M16x1	19	17	20	24
M24x1.5	27	27	47	56
M30x1.5	36	32	79	93
	36	36	79	93
M38x1.5	46	46	130	153
G-thread (flat-sealing)	Adapt the torque to the material of the flat seal used. First hand-tighten the temperature control hose. When using adapters, do not overtighten the G-thread on the pump connection when connecting a temperature control hose. When connecting a temperature control hose to the adapter piece, secure the G thread against overwinding.			

## 2.7 Temperature control units with cooler

Valid heating circulators with >Cooling coil< [29]

**WARNING**

**Open electrical wires below the temperature control unit if the temperature falls below the dew point.**

**DEATH FROM ELECTRICAL SHOCK BY WATER ENTRY INTO THE ELECTRIC LINES.**

- A temperature below the dew point may result in condensation in the temperature control unit and at the cooling water connections. The condensation is caused by high humidity at the cooling water-bearing components. The condensation exists the temperature control unit at the bottom.
- Electrical lines directly below the temperature control unit must be protected against liquid ingress.

**CAUTION**

**Use of unsuitable/defective hoses and/or hose connections**

**INJURIES**

- **Thermal fluid**
- Use appropriate hoses and/or hose connections.
- Check periodically for leaks and the quality of the hose and hose connections and take suitable measures (replace) as required.
- Isolate and protect temperature control hoses against contact/mechanical load.
- **Cooling water**
- Reinforced hoses must be used to satisfy tougher safety requirements.
- Shut off the cooling water supply to the temperature control unit even for shorter downtimes (e.g. overnight).

**CAUTION**

**Steam or hot water escapes at the >cooling coil< [29]**

**SEVERE BURNS**

- Do not use the >cooling coil< [29] at bath temperatures > 95 °C.
- Provide a greater flow rate through the >cooling coil< [29] at bath temperatures > 60 °C.

**NOTE**

**No protection against corrosion**

**DAMAGE TO THE TEMPERATURE CONTROL UNIT**

- The addition of anti-corrosion agents is mandatory if salts (chlorides, bromide) have been added to the water circuit.
- Ensure that the materials used in the cooling water circuit are resistant with respect to the cooling water. For information on materials used see the data sheet. → From page 58, section »Annex«.
- Take suitable measures to maintain the warranty conditions.
- For information about water quality, see [www.huber-online.com](http://www.huber-online.com).

**NOTE**

**Usage of un-filtered river/sea or ocean water as cooling water**

**DAMAGE TO THE TEMPERATURE CONTROL UNIT**

- Un-filtered river or sea water is not suitable for use as cooling water due to its contaminants.
- Use drinking water or filtered river or sea water for cooling.
- Sea water must not be used for water cooling.
- For information about water quality, see [www.huber-online.com](http://www.huber-online.com).

**INFORMATION**

The >Cooling coil< [29] scales at cooling water temperatures > 60 °C according to the water quality. Descale regularly and on time. Follow the instructions for the proper disposal. → Page 15, section »Proper disposal of resources and consumables«.

Observe all legal and other requirements specified by your water supplier when connecting to the public water system.

To reach temperatures close to the ambient temperature a >Cooling coil< [29] is required. In some types of temperature control units the >Cooling coil < [29] is pre-assembled and for other types it is available as an accessory. Observe the wiring diagram. → From page 58, section »Annex«.

**PROCEDURE**

- Connect one of the connectors to your cooling water inlet and the other to your cooling water return flow (no preferred direction).
- Only use the >cooling coil< [29] at bath temperatures at less than 95 °C.
- Provide sufficient flow at high bath temperatures (between 60 °C and 95 °C) to prevent excessive scaling of the >cooling coil< [29] and the return line.
- Shut off the cooling water supply during heating. You will save energy and achieve shorter heating times.



## 2.8 Temperature control unit with batch

### 2.8.1 Operation as bath thermostat

Figure bath thermostat

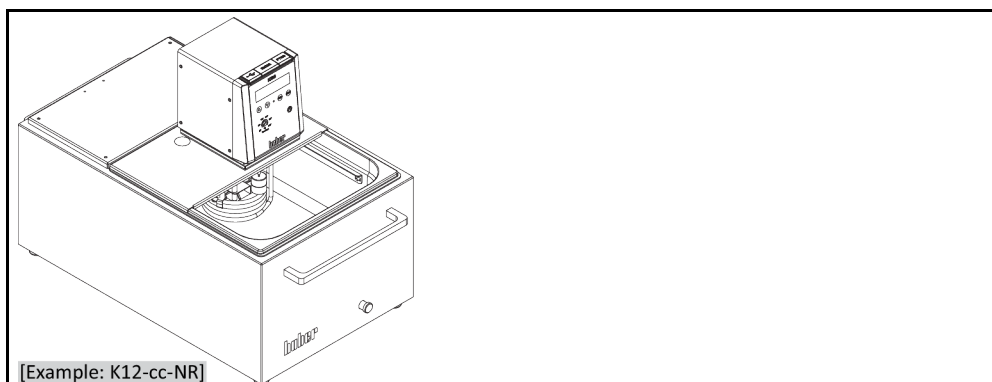

Note the volume displacement caused by a sample (e.g. Erlenmeyer flask). Place your sample into the empty bath. Only then fill in a sufficient amount of temperature control medium. Also note that the level of the temperature control medium drops when you remove the sample. This may cause a safety shutdown (low level protection) during an enabled thermoregulation. Therefore, switch off the temperature control unit beforehand.

## 2.9 Preparations for operation

### 2.9.1 Unscrewing/activating the leveling feet (if any)



**The leveling feet are not unscrewed/activated before switching on the temperature control unit DEATH OR SERIOUS INJURY DUE TO CRUSHING**

- The parking brakes must be activated at the casters (if any) and/or the leveling feet must be unscrewed/activated before the temperature control unit is put into operation.
- The temperature control unit may move if the parking brakes of the casters (if any) are not activated and/or the leveling feet are not unscrewed/activated.

Always unscrew/activate the leveling feet before switching on the temperature control unit. Uneven floors can be compensated by adjusting these leveling feet.

## PROCEDURE

- Verify that the parking brakes of the casters (if any) have been activated.
- Unscrew the leveling feet.
- Compensate uneven floors by adjusting these leveling feet, if necessary. Use a spirit level to horizontally align the temperature control unit.
- Tighten the lock screws on the leveling feet after aligning the temperature control unit. This prevents the leveling feet from changing their height during operation.

### 2.9.2 Externally closed and externally open applications

Using a pre-assembled pump adapter that is also available as an accessory, you can also control the temperature of an external application (e.g. reactor or open bath vessel). Externally open applications can run without interference only in conjunction with a DS level stabilizer (accessory). The DS level stabilizer compensates the differences in the pump (pressure capacity and throughput). If not already attached, please install the pump adapter. In an externally open application, please also install the DS level stabilizer on the externally open bath. To do so, follow the operation manual of the DS level stabilizer and the information on filling and venting. → Page 37, section »Filling and venting the bath thermostat and the externally closed application«.

### 2.9.3 Installing collecting container

#### PROCEDURE

- Install a suitable hose at the **>overflow<** [12] on the temperature control unit (if present). The hose must be compatible with the thermal fluid and the temperature.
- Put the other end of the hose in a suitable collecting container.

### 2.9.4 Connecting the functional earth

#### PROCEDURE

- If required, connect the temperature control unit's **>Functional ground terminal<** [87] to the building's grounding point. Use a ground strap for this purpose. For the exact position and thread size please refer to the wiring diagram. → From page 58, section »Annex«.

## 2.10 Connecting externally closed application

Observe the wiring diagram. → From page 58, section »Annex«.

### 2.10.1 Connecting an externally closed application

**NOTE**

**Overpressure in the application (e.g. > 0.5 bar (g) with glass apparatus)**

**MATERIAL DAMAGE TO THE APPLICATION**

- Provide an overpressure protective device to prevent damage to the application.
- Do not install valves/quick-release couplings in the feed/discharge lines from the temperature control unit to the application and from the application to the temperature control unit.
- **If valves/quick-release couplings are required:**
- Install burst disks on the application itself (at the feed and discharge lines).
- Install a bypass upstream of the valves/quick-release couplings for the application.
- Matching accessories (e.g. bypasses to reduce pressure) can be found in the Huber catalog.

Example: Connecting an externally closed application

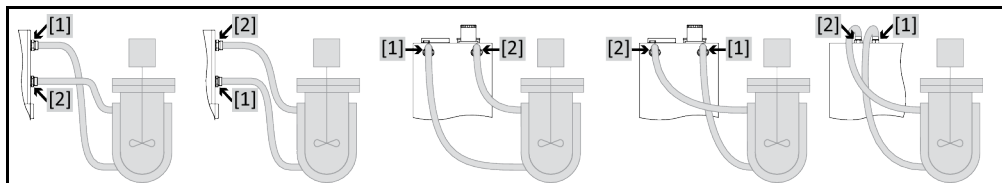

To enable your application to be operated correctly and eliminate air bubbles from the system, you must ensure that the **>Circulation flow<** [1] connection from the temperature control unit is attached to the lower connection point of the application and the **>Circulation return<** [2] into the temperature control unit is attached to the higher connection point of the application.

#### PROCEDURE

- Remove the screw plugs from the **>Circulation flow<** [1] and **>Circulation return<** [2] connections.
- Then connect your application to the temperature control unit using suitable thermal fluid hoses. Observe the table with the wrench sizes. → Page 23, section »Wrench sizes and torques«.
- Check the connections for leaks.

## 2.11 Connecting to the power supply

**INFORMATION**

Based on local circumstances, it may be that you need to use an alternative power cable instead of the supplied original power cable. Do not use a power cable that is longer than **3 m** to be able to disconnect the temperature control unit at any time from the mains. Have the mains cable only replaced by a qualified electrician.

### 2.11.1 Connection using socket with protective earth (PE)

**DANGER**

**Connecting to a power socket without protective earth (PE)**  
**MORTAL DANGER FROM ELECTRIC SHOCK**

- Always connect the temperature control unit to safety sockets (PE).

**DANGER**

**Damaged power cable/power cable connection**  
**MORTAL DANGER FROM ELECTRIC SHOCK**

- Do not start up the temperature control unit.
- Isolate the temperature control unit from the power supply.
- Have the power supply cable/power supply connection replaced and inspected by an electrician.
- Do not use a power cable that is longer than **3 m**.

**NOTE**

**Incorrect power supply connection**  
**DAMAGE TO THE TEMPERATURE CONTROL UNIT**

- Your building's existing power supply voltage and frequency must match the data provided on the rating plate of the temperature control unit.

**INFORMATION**

In case of uncertainties about an existing protective earth (PE), have the connection inspected by an electrician.

### 2.11.2 Connection via hard wiring

**DANGER**

**Connection/adjustment to the power supply not carried out by an electrician**  
**MORTAL DANGER FROM ELECTRIC SHOCK**

- Have the connection/adjustment to the power supply carried out by an electrician.

**DANGER**

**Damaged power cable/power cable connection**  
**MORTAL DANGER FROM ELECTRIC SHOCK**

- Do not start up the temperature control unit.
- Isolate the temperature control unit from the power supply.
- Have the power supply cable/power supply connection replaced and inspected by an electrician.
- Do not use a power cable that is longer than **3 m**.

**NOTE**

**Incorrect power supply connection**  
**DAMAGE TO THE TEMPERATURE CONTROL UNIT**

- Your building's existing power supply voltage and frequency must match the data provided on the rating plate of the temperature control unit.

## 3 Function description

### 3.1 Function description of the temperature control unit

#### 3.1.1 General functions

The heating circulators are **temperature control units** ideally suited for the thermoregulation of baths.

Due to the powerful **heat technology**, **short heating times** can be achieved.

#### 3.1.2 Other functions

A pump ensures the thermal fluid is circulated. The following data are displayed on the **display with OLED technology** depending on the model and options: temperature of the internal and external temperature sensor, setpoint. Use the membrane keyboard to enter the controller settings.

The temperature control unit can easily be integrated in many laboratory automation systems using the **standardly existing RS232 and USB interfaces on the controller**.

An external Pt100 sensor can be connected via the optional **Pt100 process display sensor port**. The temperature measured is displayed on the display.

Temperature control units with a heater have an **overtemperature protection to DIN EN 61010-2-010 that is independent** of the control circuit.

### 3.2 Information on the thermal fluids

#### CAUTION

**Non-compliance with the safety data sheet for the thermal fluid to be used**

##### INJURIES

- Risk of injury to the eyes, skin, respiratory tract.
- The safety data sheet for the thermal fluid to be used must be read prior to using it and its content must be respected.
- Observe the local regulations/work instructions.
- Wear your personal protective equipment (e.g. temperature-resistant safety gloves, safety goggles, safety footwear).
- Danger of slipping because floor and work area are contaminated. Clean the workplace; observe the proper disposal of thermal fluid and aids. → Page 15, section »**Proper disposal of re-sources and consumables**«.

#### NOTE

**Non-compliance with the compatibility between the thermal fluid and your temperature control unit**

##### MATERIAL DAMAGE

- Observe the classification of your temperature control unit according to DIN 12876.
- Ensure the following materials are resistant with respect to the thermal fluid: Stainless steel 1.4301/ 1.4401 (V2A), copper, nickel, FKM, red bronze/brass, silver solder and plastic.
- The maximum viscosity of the thermal fluid must not exceed 50 mm<sup>2</sup>/s at the lowest working temperature!
- The maximum density of the thermal fluid may not exceed 1 kg/dm<sup>3</sup>!

#### NOTE

**Mixing different thermofluids in a thermal fluid circuit**

##### PROPERTY DAMAGE

- Do **not** mix different types of thermofluid (such as mineral oil, silicone oil, synthetic oil, water, etc.) in a thermofluid circuit.
- The thermal fluid circuit **must** be rinsed when changing from one type of thermal fluid to another. No residues of the previous type of thermal fluid may remain in the thermal fluid circuit.

Thermal fluid: Water

Designation	Specification
Calcium carbonate per liter	≤ 1.5 mmol/l; corresponds to a water hardness of: ≤ 8.4 °dH (soft)
pH value	between 6.0 and 8.5
Ultrapure water, distillates	Add 0.1 g of sodium carbonate (Na <sub>2</sub> CO <sub>3</sub> ) per liter
Non-approved water	Distilled, deionized, demineralized, chloric, ferruginous, ammoniacal, contaminated or untreated river water or sea water
Volume circulated (at least)	3 l/min.
<b>Thermal fluid: Water without ethylene glycol</b>	
Use	≥ 0 °C
<b>Thermal fluid: Water-ethylene glycol mixture</b>	
Use	< 0 °C
Thermal fluid composition	The mixture's temperature must be 10 K below the permissible min. temperature. For the permissible temperature range, refer to the datasheet. → From page 58, section »Annex«.

**INFORMATION**

For thermal fluids we recommend the media listed in the Huber catalog. The name of a thermal fluid is derived from its working temperature range and its viscosity at 25 °C.

### 3.3 To be noted when planning the test

**INFORMATION**

Observe the intended operation. → Page 13, section »Proper operation«.

The focus is on your application. Bear in mind that system performance is influenced by heat transfer, temperature, thermal fluid viscosity, volume flow, and flow speed.

- Make sure that the electrical connection is adequately dimensioned.
- The installation location of the temperature control unit should be selected so as to ensure adequate fresh air, even with water-cooled chillers.
- Select the thermal fluid to be used in such a way that it not only permits the minimum and maximum working temperature but is also suitable with regard to fire point, boiling point, and viscosity. In addition, the thermal fluid must be compatible with all the materials in your system.
- Basically, you should only use the thermal fluid recommended by the manufacturer and only within the usable temperature and pressure range.
- The application should be roughly at the same height of or below the temperature control unit if the thermoregulation is close to the boiling temperature of the thermal fluid.
- Fill the temperature control unit slowly, carefully and evenly. Wear the necessary personal protective equipment, such as goggles, heat-proof and chemical-resistant gloves, etc.

**INFORMATION**

For water-cooled temperature control units, please take the cooling water temperature necessary for perfect operation and the required differential pressure from the data sheet. → From page 58, section »Annex«.

### 3.4 Display and control instruments

The control panel:  
Displays and keys

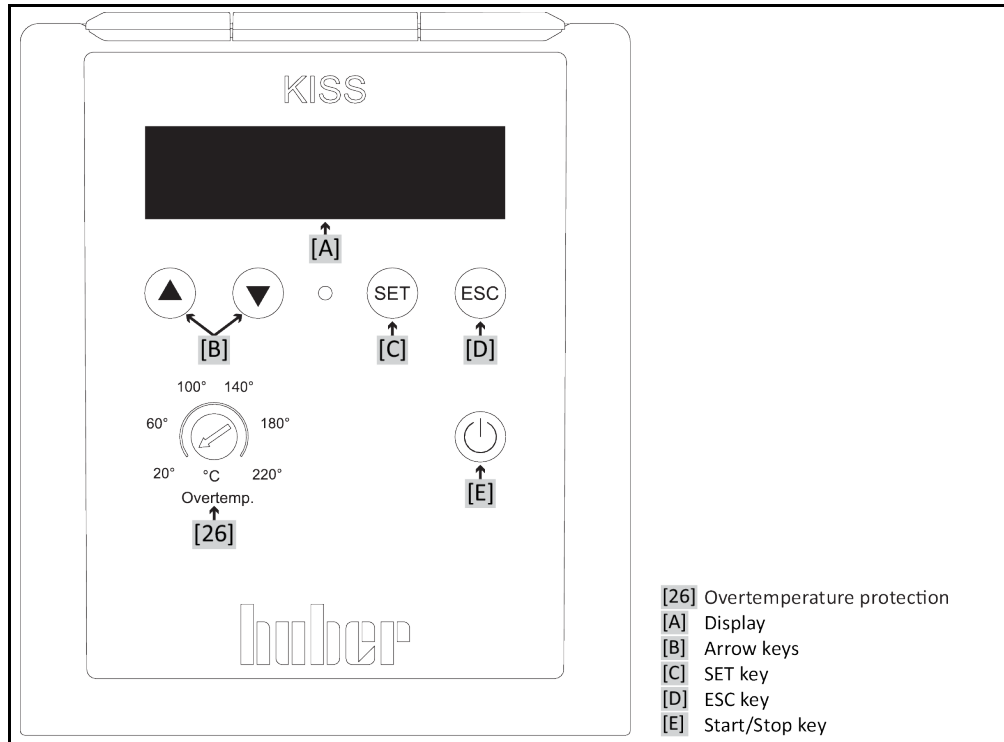

#### 3.4.1 Display

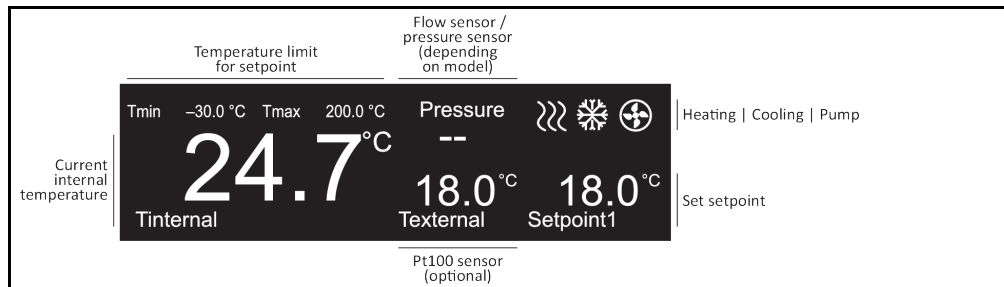

Home screen:  
Temperature control is active

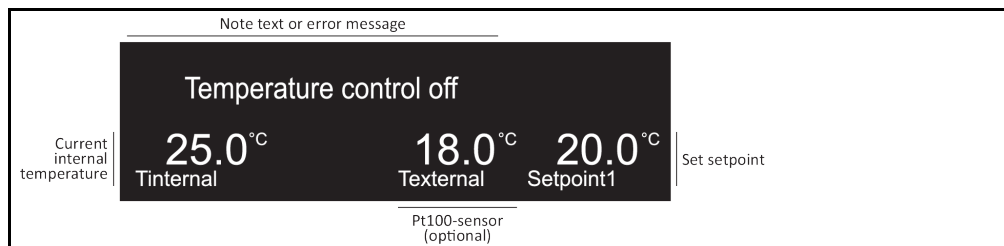

Home screen:  
Temperature control is inactive or an error message is displayed



Home screen:  
Explanation of the  
display

Designation	Description
Temperature limit for setpoint	Display of the setpoint limit. You can set the setpoint only within this range. You can change this limit in the menu item "Protection Options" and then "Setpoint Minimum" and "Setpoint Maximum". Do take the thermal fluid used and the material to be tempered into account when changing these settings. → Page 33, section »Menu function«.
Flow sensor / pressure sensor (optional, depending on model)	Display for the measured values of the built-in flow or pressure sensor. This feature is optional depending on the model and is not available in KISS controllers and other temperature control units. Use the menu item "Sensor Configuration" under "Flow Sensor / Pressure Sensor Display" to change the display or to turn it on and off. → Page 33, section »Menu function«.
 Heating	This symbol is displayed when the temperature control unit heats the thermal fluid. (Only for temperature control units with heating)
 Cooling system	This symbol is displayed when the temperature control unit cools down the thermal fluid.
 Pump	The symbol is displayed when the pump in the temperature control unit runs.
Current internal temperature	Display of the current thermal fluid temperature. The temperature is measured and controlled by the internal temperature sensor.
Pt100 sensor (optional)	Displays the measured value of the external Pt100 process display sensor. This display requires that: 1) the temperature control unit is equipped with a Pt100 port, 2) a Pt100 process display sensor has been attached, 3) the Pt100 process display sensor was placed in the application. You can turn on and off the display in the menu item "Sensor Configuration" under "Display external Pt100 sensor" only if the corresponding interface has been installed. → Page 33, section »Menu function«.
Set setpoint	Displays the setpoint set.
Info text or error message	Displays an info text or error message.

### 3.4.2 Control instruments

#### 3.4.2.1 Arrow keys

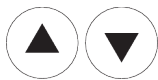

Use the >Arrow keys< [B] to enter values (⬅ (+) or ⬇ (-)), to select a menu item (⬅ (arrow left) or ⬆ (arrow right)) or to select a different menu item (⬆ (up) or ⬇ (down)). Pressing an arrow key for an extended period changes a value faster. Pressing both >Arrow keys< [B] simultaneously calls up the main menu.

#### 3.4.2.2 SET key



Pressing the >SET key< [C] on the home screen switches directly to the screen where you can enter the setpoint temperature. It allows you to quickly modify the setpoint temperature. The >SET key< [C] is also used to get to a selected menu item or to confirm changes.

#### 3.4.2.3 ESC key



Pressing the >ESC key< [D] cancels changes / entries. The display changes to the previous screen without saving a change / entry. Pressing the >ESC key< [D] brings you back to the previous screen, all the way to the home screen. Press the >ESC key< [D] to acknowledged the alarm sound of an error.

**3.4.2.4 Start/Stop key**



Start or stop the thermoregulation by pressing the >Start/Stop button< [E].

**3.4.3 Adjusting settings**

Exemplary setting of a numerical value



Exemplary setting by text selection

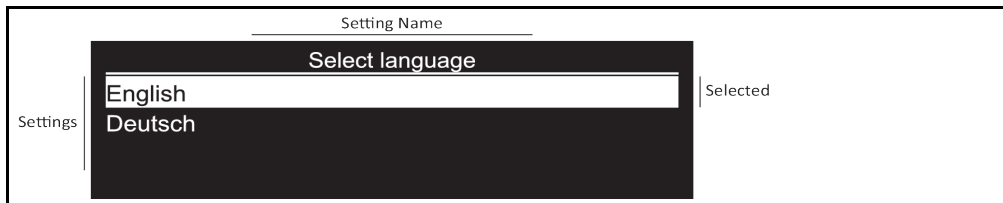

There are two ways to adjust settings:

**Numerical settings:**

Use the >Arrow keys< [B] (⬆ (+) or ⬇ (-)) and confirm an entry by pressing the >SET key< [C]. Pressing an arrow key for an extended period changes a value faster.

**Text selection:**

Select the text via the >Arrow keys< [B] (⬆ (up) or ⬇ (down)) and confirm your entry by pressing the >SET key< [C].



### 3.5 Menu function

Main menu

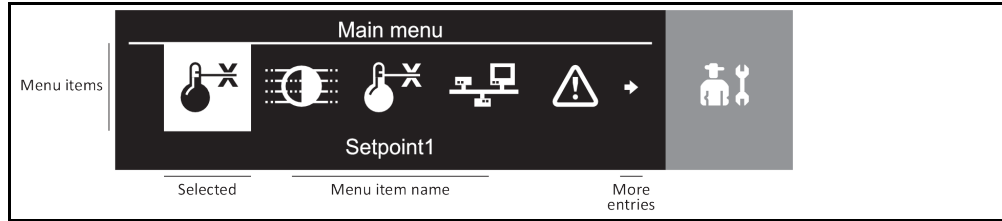

Pressing both >Arrow keys< [B] simultaneously calls up the main menu. Some menu items cannot be selected depending on the configuration of the temperature control unit.

Overview of the menu items

Display	Description	KISS	OLÉ
Setpoint 1	Sets the setpoint. Use the >Arrow keys< [B] to change the setpoint.	X	X
Adjusting brightness	Adjusting the brightness of the OLED display. Use the >Arrow keys< [B] to change the brightness.	X	X
Sensor configuration	This menu item makes available: 1) Adjustment of the internal sensor (input options: Offset (K)) 2) Adjustment of the external sensor (input options: Offset (K)) 3) Temperature unit (choose between "Celsius" and "Fahrenheit") 4) Mode (choose between "Internal temperature control", "Venting" and "Circulation") 5) Display of external Pt100 sensor – (activating the display of an external Pt100 process display sensor) 6) Flow sensor / pressure sensor display – (activating the display of the optional flow sensor / pressure sensor)	X O X X O –	X O X X O M
Interfaces	This menu item makes available: 1) RS232 1 (setting of "Baud rate" and "Mode" (HuberBus)) 2) RS232 2 (setting of "Baud rate" and "Mode" (HuberBus)) 3) USB device (setting of "Baud rate" and "Mode" (HuberBus)) <b>Only Huber service technicians may use the "STBus" mode.</b> 4) Floating contact (selection of "Off", "Alarm" and "Unipump/PCS") 5) External control signal (selection between "Off", "Setpoint2" and "Standby")	X X X – –	X O X O O
Protection Options	This menu item makes available: 1) Setpoint2 (to input the second setpoint) 2) Setpoint minimum (to input the lower limit of the adjustable setpoint) 3) Setpoint maximum (to input the upper limit of the adjustable setpoint) 4) Power failure automatic (select between "Off" and "Automatic")	– X X X	O X X X
System	This menu item makes available: 1) Heating output (only with temperature control units; setting in %) 2) Select language (choose between "English" and "German") 3) Cooling bath (select between "Without cooling bath" (Off), "With cooling bath and common power supply" (On) and "With cooling bath and separate power supply" (On)) 4) System information (display different serial numbers (Serial Number) and version statuses) 5) Service menu (only for Huber service technicians. This submenu is password protected) 6) Factory settings (choose between "Continue" and "Cancel")	X X M X X X	M X – X X X
X = standard, O = optional, M = model-dependent – = not possible			

## 3.6 Functional examples

### 3.6.1 Selecting a language

#### PROCEDURE

- Press both >Arrow keys< [B] to invoke the main menu.
- Use the >Arrow keys< [B] to select the menu item "System".
- Press the >SET key< [C] to confirm your selection.
- Use the >Arrow keys< [B] to select the submenu "Select Language".
- Press the >SET key< [C] to confirm your selection.
- Use the >Arrow keys< [B] to select the desired language.
- Press the >SET key< [C] to confirm your selection.
- Press the >ESC key< [D] twice to return to the home screen.

### 3.6.2 Setting the setpoint

#### PROCEDURE

##### Using the home screen to set the setpoint

- Press the >SET key< [C].
- Use the >Arrow keys< [B] (⬆ (+) or ⬇ (-)) to set the new setpoint.  
The longer you keep an arrow key pressed the faster the value changes.
- Press the >SET key< [C] to confirm your input.

### 3.6.3 Changing the Auto-Start function

Following a power outage (or when switching on the temperature control unit), this function can be used to determine how the temperature control unit is supposed to respond.

#### Auto-Start function is turned off

The temperature control is started only by manual input when the temperature control unit is turned on.

#### Auto-Start function is turned on

The temperature control unit is set to the same state it was in before the power outage. For example, before the power outage: Thermoregulation is off; after power outage: Thermoregulation is off. If temperature control is active during a power outage, the process will automatically continue after the power outage.

#### PROCEDURE

- Press both >Arrow keys< [B] to invoke the main menu.
- Use the >Arrow keys< [B] to select the menu item "Protection Options".
- Press the >SET key< [C] to confirm your selection.
- Use the >Arrow keys< [B] to select the submenu "Power Failure Automatic".
- Press the >SET key< [C] to confirm your selection.
- Use the >Arrow keys< [B] to select the desired setting.
- Press the >SET key< [C] to confirm your selection.
- Press the >ESC key< [D] twice to return to the home screen.

## 4 Setup mode

### 4.1 Setup mode



**Moving the temperature control unit during operation**  
**SERIOUS BURNS/FREEZING OF THE HOUSING PARTS/ESCAPING THERMAL FLUID**  
 ➤ Do not move temperature control units that are in operation.

#### 4.1.1 Turning on the temperature control unit

##### PROCEDURE

- The temperature control unit must be filled with thermal fluid before you turn it on via the **>Mains switch<** [37]. → Page 37, section »Filling, venting, degassing and draining«. An error message appears on the display after a short time if the temperature control unit is switched on without thermal fluid. If this is the case, switch off the temperature control unit using the **>Mains switch<** [37] and fill it.
- Switch on the temperature control unit using the **>Mains switch<** [37]. The float switch monitors the thermal fluid level. For this, the float switch is automatically pressed down. The buoyancy of the float forces it upwards only when thermal fluid is filled and thus the test is passed. The test may generate some sounds. Circulation and temperature control are turned off.

#### 4.1.2 Turning off the temperature control unit

##### PROCEDURE

- Warm the thermofluid to room temperature.
- Stop the thermoregulation.
- Switch off the temperature control unit using the **>Mains switch<** [37].

#### 4.1.3 Setting the overtemperature (OT) protection



**The overtemperature protection is set higher than the ignition temperature of the thermal fluid used**  
**MORTAL DANGER FROM FIRE**  
 ➤ The overtemperature protection must be correctly set to the thermal fluid you are using.  
 ➤ Always observe the safety data sheet of the thermal fluid.  
 ➤ Set the cut-out value of the overtemperature protection at least 25 K below the fire point of the thermal fluid.

##### 4.1.3.1 General information on the overtemperature protection

Example of a potentiometer at the temperature control unit

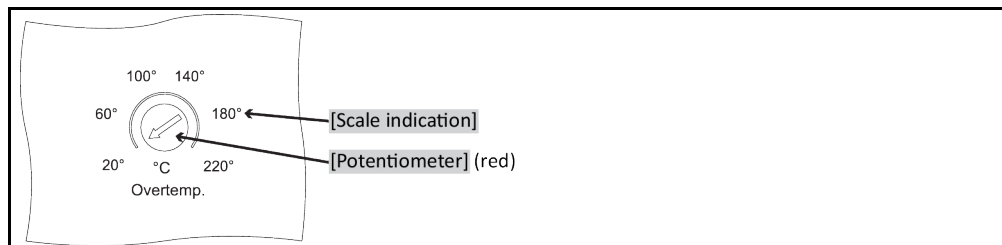

The overtemperature protection is installed only in temperature control units that have a heater. The flow temperature is monitored to ensure the safety of your system. It is set immediately after you have filled the system with thermal fluid.

Upon delivery, the cut-out value of the overtemperature protection is set to 40 °C. An alarm is triggered by the temperature control unit shortly after turning on the power if the temperature of the

thermal fluid just filled is higher than the cut-out value set for the overtemperature protection. Set the overtemperature protection to the thermal fluid you are using. Please note: The printed scale can deviate by - 25 K from the set cut-out value.

#### 4.1.3.2 Setting the overtemperature protection

Setting the cut-out value

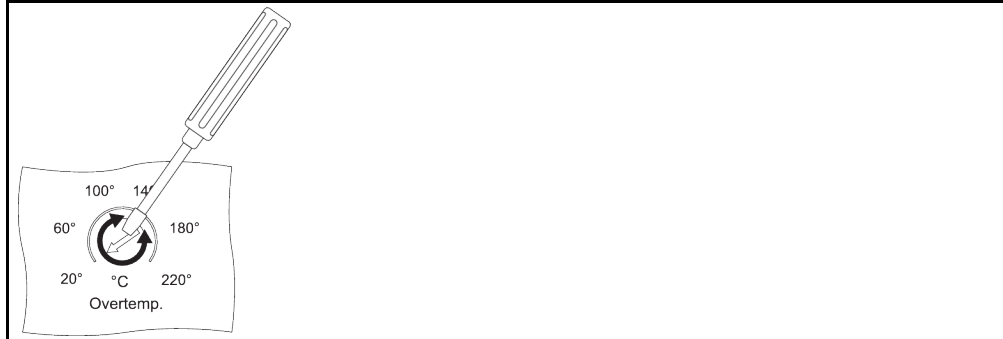

#### INFORMATION

You need a screwdriver (flat blade 1.0 x 5.5) to set the cut-out value of the overtemperature protection.

### PROCEDURE

- Use a screwdriver to set the cut-off value on the potentiometer. The cut-out value must be set to match the thermal fluid you are using. It is not required to switch on the temperature control unit.

#### 4.1.4 Testing overtemperature protection for functionality

#### DANGER

**Overtemperature protection (OT) does not trip  
MORTAL DANGER FROM FIRE**

- Test the response of the device every month and after each change of the thermal fluid in order to assure proper functioning.

#### NOTE

**The steps below are carried out without permanent monitoring of the temperature control unit  
DAMAGE TO AND IN THE VICINITY OF THE TEMPERATURE CONTROL UNIT**

- The following actions may only be carried out while constantly monitoring the temperature control unit and the application!

#### INFORMATION

The overtemperature protection is installed only in temperature control units that have a heater. You need a sufficiently large-sized screwdriver to check the overtemperature protection for functionality.

**Steps to test the correct functioning of the overtemperature protection:**

### PROCEDURE

- Note down the cut-out value of the overtemperature protection set on the potentiometer.
- Switch on the temperature control unit.
- Enter a setpoint (room temperature). → Page 34, section »Setting the setpoint«.
- Start the temperature control process by pressing the >Start/Stop button< [E].
- Use a screwdriver to set the new cut-off value on the potentiometer. This cut-out value must be **below** the indicated internal temperature. The overtemperature protection is triggered.
- Turn off the temperature control unit.
- Use a screwdriver to reset the cut-off value on the potentiometer to the original value.

#### INFORMATION

Immediately take the temperature control unit out of operation if the overtemperature protection is not triggered. Immediately contact Customer Support. → Page 57, section »Contact data«. Do not put the temperature control unit back into operation.

## 4.2 Filling, venting, degassing and draining

Observe the wiring diagram. → From page 58, section »Annex«.

### CAUTION

#### Extremely hot / cold surfaces, connections and thermal fluids

##### BURNS/FREEZING OF LIMBS

- Surfaces, connections and tempered thermal fluids can be extremely hot or cold depending on the operating mode.
- Avoid direct contact with surfaces, connections and thermal fluids!
- Wear your personnel protective equipment (e.g. temperature-resistant safety gloves, safety goggles).

### NOTE

#### During an active circulation, the thermal fluid circuit is shut off by shut-off valves

##### MATERIAL DAMAGE TO THE CIRCULATING PUMPS INSTALLED IN THE TEMPERATURE CONTROL UNIT

- Do not close the thermal fluid circuit during an active circulation by means of shut-off valves.
- Warm the thermal fluid to room temperature before stopping the circulation.

### 4.2.1 Filling, venting, degassing and draining the bath thermostat

### CAUTION

#### Non-compliance with the safety data sheet for the thermal fluid to be used

##### INJURIES

- Risk of injury to the eyes, skin, respiratory tract.
- The safety data sheet for the thermal fluid to be used must be read prior to using it and its content must be respected.
- Observe the local regulations/work instructions.
- Wear your personal protective equipment (e.g. temperature-resistant safety gloves, safety goggles, safety footwear).
- Danger of slipping because floor and work area are contaminated. Clean the workplace; observe the proper disposal of thermal fluid and aids. → Page 15, section »Proper disposal of resources and consumables«.

#### 4.2.1.1 Filling and venting the bath thermostat and the externally closed application

## PROCEDURE

- Check that a hose was installed at the >Overflow< [12] (if present). The other end of the hose must be inserted in a suitable collecting container. Excess thermal fluid will leak at this point when the temperature control unit is overfilled. Hose and container must be compatible with the thermal fluid and its temperature.
- Lift the >Bath cover< [93] from the temperature control unit.
- Using the filling accessories (funnel and/or beaker), carefully fill in suitable thermal fluid. While filling, pay attention to any necessary measures such as grounding the containers, funnels and other accessories. The thermal fluid can flow via the hose connections to the external application. Follow the instructions for the proper disposal when cleaning filling accessories. → Page 15, section »Proper disposal of resources and consumables«.
- Switch on the temperature control unit.
- Set the setpoint to room temperature (about 20 °C). → Page 34, section »Setting the setpoint«.
- Start the temperature control process by pressing the >Start/Stop button< [E].
- The filling/venting process is complete when the bath vessel is filled sufficiently and the liquid level remains constant.
- Stop the temperature control process by pressing the >Start/Stop button< [E].
- Put the >Bath cover< [93] back onto the bath opening.
- Turn off the temperature control unit.

### INFORMATION

The volume expansion of the thermal fluid depends on the working temperature range you wish to work in. Do not go below the minimum bath level/minimal level when working at the "lowest" working temperature and there should be no overflow from the expansion vessel/temperature control unit when working at the "highest" working temperature. In case of overfilling, drain the excess amount of thermal fluid. → Page 38, section »Draining the bath thermostat«. Check if the thermal fluid can be reused. Follow the instructions for the proper disposal. → Page 15, section »Proper disposal of resources and consumables«.

- Check the fill level in the collecting container. Empty the container when necessary and dispose of its contents properly.
- In case of overfilling, drain thermal fluid via the >Drain< [8] into a suitable container (see page

→ Page 38, section »**Draining the bath thermostat**«. Check if the thermal fluid can be reused. Follow the instructions for the proper disposal. → Page 15, section »**Proper disposal of resources and consumables**«.

#### 4.2.1.2 Degassing of bath thermostat



##### Hot or cold thermal fluid and surfaces

##### BURNS TO LIMBS

- Avoid direct contact with the thermal fluids or the surfaces.
- Wear your personnel protective equipment (e.g. temperature-resistant safety gloves, safety goggles, safety footwear).

#### INFORMATION

When changing from low-boiling thermal fluid (low-boiling components) to higher boiling thermal fluids, remains of the low-boiling component may remain in the temperature control unit. Depending on the working temperature, the low-boiling component begins to boil and gas bubbles are formed that cause the pump pressure to momentarily collapse. This may cause a safety shutdown. The gas bubbles reach the bath opening and can escape.

If ice crystals form on the evaporator coil, water has accumulated in the thermal fluid. Degas if this is the case, to avoid damage to the temperature control unit.

Thermal fluids are more or less hygroscopic (water-attracting). This effect increases, the lower the working temperature. The de-gassing mode below, which must be **permanently monitored**, also helps you remove any water residues from the temperature control circuit.

## PROCEDURE

- Follow venting with the degassing operation. Prerequisite: You have filled and/or cleaned the temperature control unit in accordance with the instructions. → Page 37, section »**Filling and venting the bath thermostat and the externally closed application**« and/or → Page 51, section »**Rinsing the thermal fluid circuit**«.
- Enter a setpoint. → Page 34, section »**Setting the setpoint**«. This setpoint must be below the lower boiling thermal fluid. This setpoint will be increased in 10 K steps during the degassing process up to the maximum working temperature.
- Starting the temperature control process. → Page 40, section »**Starting the temperature control process**«.
- Carry out temperature control to the entered setpoint until no more gas bubbles rise up.
- Increase the setpoint by 10 K and carry out temperature control until no more gas bubbles rise up.
- Repeat increasing the setpoint by 10 K until the maximum working temperature of the thermal fluid has been reached.
- Stopping the temperature control process. → Page 40, section »**Ending the temperature control process**«.
- The de-gassing process is complete.

#### 4.2.1.3 Draining the bath thermostat



##### Hot or very cold thermal fluid

##### SEVERE BURNS/FROSTBITE OF LIMBS

- Before draining, ensure that the thermal fluid has room temperature (20 °C).
- If, at this temperature, the thermal fluid is too viscous to be drained: Control the temperature of the thermal fluid for a few minutes until the viscosity will allow drainage. Never control the temperature of the thermal fluid when the drain is open.
- Danger of burns when draining thermal fluids at temperatures above 20 °C.
- Wear your Personal Protective Equipment for draining.
- Only drain using suitable drainage hose and collecting container. These must be compatible with the thermal fluid and its temperature.

## PROCEDURE

### Baths with >Drain valve< [4]

- Remove the knurled screw at the >Drain< [8].
- Connect a suitable drain hose to the >Drain< [8].
- Place the other end of the hose in a suitable container.

- Open the **>Drain valve<** [4] by turning it counterclockwise (turn 90° left as far as it will go). The thermal fluid will flow from the external application via the bath vessel and the draining hose into the container. Check if the thermal fluid can be reused. Follow the instructions for the proper disposal. → Page 15, section »**Proper disposal of resources and consumables**«.
- Wait until the external application and the bath are empty.
- Open the connection **>Circulation flow<** [1].
- Open the connection **>Circulation return<** [2].
- Leave the temperature control unit open for a while to allow it to dry out and the residue to drain. Without screw caps and with the **>Drain valve<** [4] open.
- Close the **>Drain valve<** [4] by turning it clockwise (turn 90° right as far as it will go).
- Close the connection **>Circulation flow<** [1].
- Close the connection **>Circulation return<** [2].
- After drying out, remove the drain hose and re-fit the knurled screw to the **>Drain<** [8].
- The bath is now drained.

#### **Baths without >Drain valve< [4]**

- Have a suitable container ready to catch the thermal fluid.
- Open the knurled screw at the **>Drain<** [8]. As soon as you have opened the knurled screw, the thermal fluid will flow from the external application over the bath and into the container. Wait until the external application and the bath are empty. Check if the thermal fluid can be reused. Follow the instructions for the proper disposal. → Page 15, section »**Proper disposal of resources and consumables**«.
- Open the connection **>Circulation flow<** [1].
- Open the connection **>Circulation return<** [2].
- Leave the temperature control unit open for a while for the residue to fully drain and to allow it to dry out (without screw caps).
- Close the connection **>Circulation flow<** [1].
- Close the connection **>Circulation return<** [2].
- Re-fit the knurled screw to the **>Drain<** [8].
- The bath is now drained.

## 5 Normal operation

### 5.1 Automatic operation

**CAUTION**

**Extremely hot / cold surfaces, connections and thermal fluids**

**BURNS/FREEZING OF LIMBS**

- Surfaces, connections and tempered thermal fluids can be extremely hot or cold depending on the operating mode.
- Avoid direct contact with surfaces, connections and thermal fluids!
- Wear your personnel protective equipment (e.g. temperature-resistant safety gloves, safety goggles).

**NOTE**

**During an active circulation, the thermal fluid circuit is shut off by shut-off valves**

**MATERIAL DAMAGE TO THE CIRCULATING PUMPS INSTALLED IN THE TEMPERATURE CONTROL UNIT**

- Do not close the thermal fluid circuit during an active circulation by means of shut-off valves.
- Warm the thermal fluid to room temperature before stopping the circulation.

#### 5.1.1 Temperature control

##### 5.1.1.1 Starting the temperature control process

The temperature control process can be started after filling and complete venting.

### PROCEDURE

- With the temperature control unit switched on and thermoregulation/circulation stopped, press the **>Start/Stop button< [E]**. Thermoregulation starts.

##### 5.1.1.2 Ending the temperature control process

**NOTE**

**When the temperature control unit is switched off, the thermal fluid temperature is higher/lower than room temperature**

**DAMAGE TO THE TEMPERATURE CONTROL UNIT AND THE GLASS APPARATUS/APPLICATION**

- Bring the thermal fluid up to room temperature using the temperature control unit.
- Do not close the shut-off valves in the thermal fluid circuit.

Thermoregulation can be terminated at any time. Thermoregulation and circulation are switched off immediately afterwards.

### PROCEDURE

- With the temperature control unit switched on and thermoregulation/circulation started, press the **>Start/Stop button< [E]**. Thermoregulation stops.



## 6 Interfaces and data communication

**NOTE**

**Connecting to the interfaces at the temperature control unit during operation**

**DAMAGE TO THE INTERFACES**

- When devices in operation are connected with interfaces of the temperature control unit, interfaces may get damaged.
- Before connecting, ensure the temperature control unit and the device to be connected are turned off.

**NOTE**

**The specifications of the interface used are not being met.**

**PROPERTY DAMAGE**

- Only connect components that meet the specifications of the interface used.

### 6.1 Controller interfaces

Standard interfaces on the top side of "KISS"

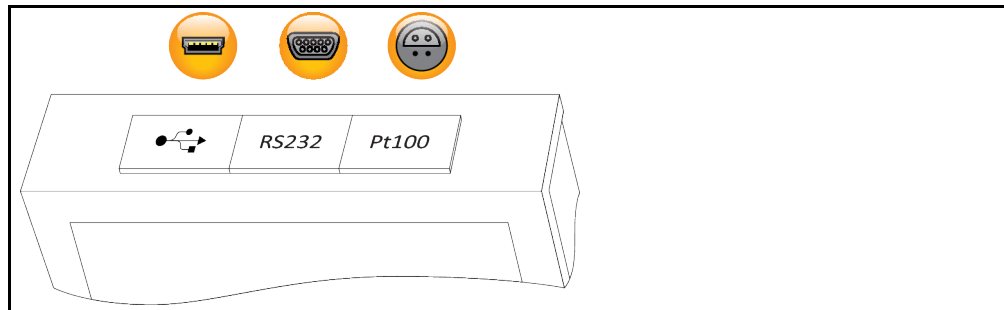

#### 6.1.1 USB-2.0 interface

**INFORMATION**

The interfaces used must meet the specifications of the generally accepted standards. The necessary drivers for the interface can be found at: [www.ftdichip.com/Drivers/VCP.htm](http://www.ftdichip.com/Drivers/VCP.htm)

##### 6.1.1.1 USB-2.0 interface, device



USB-2.0 connection (for Mini-B connector) for communicating with a computer.

##### 6.1.2 RS232 jack



A PC, a SPS or a Process Control System (PCS) can be connected to this jack for remote control of the controller electronics. Before plugging in the cable, check the settings in the "Interfaces" category and adjust if necessary.

**INFORMATION**

The interfaces used must meet the specifications of the generally accepted standards.

Pin assignment (front view)



Pin assignment

Pin	Signal	Description
2	RxD	Receive Data
3	TxD	Transmit Data
5	GND	Signal GND

### 6.1.3 Pt100 process display sensor port (option)



A temperature sensor located in the connected application (Pt100, 4-wire technology, Lemosa connector) is connected to the Pt100 port. It records and displays the external actual temperature.

**INFORMATION**

Only use **shielded** sensor cables. We recommend the external Pt100 process sensor from the Huber accessories program.

Pin assignment (front view)



Pin assignment

Pin	Signal
1	I+
2	U+
3	U-
4	I-

Pt100  
Pin 1: I+    Pin 4: I-  
Pin 2: U+    Pin 3: U-

## 6.2 Interfaces on the temperature control unit

### 6.2.1 Interfaces at the back

Interfaces at the back of the immersion circulator (exemplary layout)

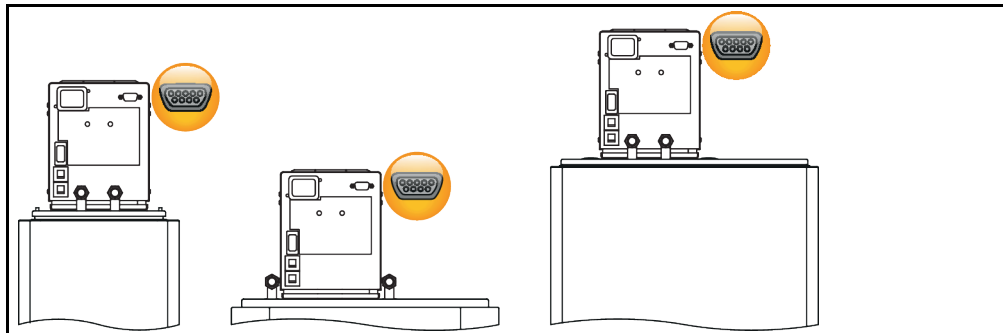

#### 6.2.1.1 RS232 jack



A PC, a SPS or a Process Control System (PCS) can be connected to this jack for remote control of the controller electronics. Before plugging in the cable, check the settings in the “Interfaces” category and adjust if necessary.

**INFORMATION**

The interfaces used must meet the specifications of the generally accepted standards.

Pin assignment (front view)



Pin assignment

Pin	Signal	Description
2	RxD	Receive Data
3	TxD	Transmit Data
5	GND	Signal GND

### 6.3 Data communication

The communication via the RS232 interface is a master-slave communication. The Master (e.g. PC or PLC) starts a communication and the slave (the temperature control unit) will only respond to a request.

**Transmission format:**

8 data bits, 1 stop bit, no parity, no handshake

These parameters are non-adjustable and cannot be changed! The baud rate can be set in a range from 9600 baud to 115200 baud.

**Time response (timing):**

The data flow of a command must not be interrupted. Pauses of more than 100 ms between the characters of a command result in the receiver aborting the incoming command. The temperature control unit will always send a response for a correctly received command. The next command can be sent once a complete response was received. The typical response time is less than 300 ms.

**INFORMATION**

You need the software "SpyControl" to transmit commands. The software can be downloaded from the download area of [www.huber-online.com](http://www.huber-online.com).

#### 6.3.1 LAI commands

There are 3 commands to communicate LAI commands to the temperature control unit:

1. "V" (Verify) – to query the device ID,
2. "L" (limit) – to query the device limits,
3. "G" (General) – to control and query the temperature control unit.

The send commands always begin with "[M01", answers always with "[S01", followed by the command qualifier "V" (Verify), "L" (Limits) or "G" (General). The next two bytes specify the length or the response of the command. A check sum is transmitted to increase data safety. The checksum is the 1 byte sum of all hex values from the start character to the last character before the checksum. It is appended to the end of the command or the response and then finished off with the end character CR ("\r", 0Dh).

Structure of a send command

Byte	Command	Response	Description
1 Byte	[	[	Start character, fix
2 Byte	M	C	Identification of the transmitter (M = Master, S = Slave)
3 bytes	0	0	Slave address, fix
4 bytes	1	1	Slave address, fix
5 bytes	V / L / G	V / L / G	Command qualifier (V = Verify, L = Limit, G = General)
6 bytes	0	1	Length of command / response (example)
7 bytes	7	4	Length of command / response (example)
n Bytes	x	x	If applicable, content; the number of bytes depends on the command
l-2 byte	C	C	Checksum (example)
l-1 byte	6	1	Checksum (example)
l byte	\r	\r	End-of-text character CR

### 6.3.1.1 Command "V" (Verify)

This command is provided to check the presence of a slave and query its ID.

Byte	ASCII	Hex	Description
Master sends: <b>[M01V07C6\r</b>			
1. Byte	[	5Bh	Start character
2. Byte	M	4Dh	Master ID
3. Byte	0	30h	Slave address
4. Byte	1	31h	Slave address
5. Byte	V	56h	Command qualifier
6. Byte	0	30h	Length of data field (0)
7. Byte	7	37h	Length of data field (7)
8. Byte	C	43h	Checksum
9. Byte	6	36h	Checksum
10. Byte	\r	0Dh	End character CR
The checksum is formed from bytes 1 to 7: $5Bh + 4Dh + 30h + 31h + 56h + 30h + 37h = 1C6h = 1 \text{ byte sum} = C6h$ The hex value C6h is appended as two ASCII characters "C" (43h) and "6" (36h).			
The slave responds: <b>[S01V14Huber ControlC1\r</b> The 13 bytes of the data set "Huber Control" plus the 7 bytes in front of the data set result in a data field length of 20 bytes = 14h bytes.			

### 6.3.1.2 Command "L" (Limit)

This command is used to query the setpoint limits.

Byte	ASCII	Hex	Description
Master sends: <b>[M01LOF*****1B\r</b>			
The slave responds: <b>[S01L17F4484E20F4484E2045\r</b>			

A response always includes four limit values (starting from the eighth byte):

1. Lower setpoint limit (4 bytes),
2. upper setpoint limits (4 bytes),
3. lower working range limit (4 bytes),
4. upper working range limit (4 bytes).

The working range limits are device-specific and cannot be changed. The lower setpoint limit can not be lower than the lower working range limit and the upper setpoint limit can not exceed the upper working range limit.

The two bytes before the last byte contain the checksum and the last byte of the response contains the end character (CR).

Each of the four values is expressed as a hex value. The values are signed, where 1 bit corresponds to 0.01 K. Thus a number range from 0000h to 7FFFh, i.e. from 0.00 °C to 327.67 °C, can be represented. Negative numbers are represented from FFFFh to 8000h, i.e. from -0.01 °C to -327.66 °C. Thus the four individual ASCII characters "F448" correspond to a 16-bit hex value of F448h and thus a temperature of -30 °C. → Page 45, section »Command "G" (General)«.

**6.3.1.3 Command “G” (General)**

This command transmits the most important temperatures and status information in a cycle. A modified setpoint is not stored in the permanent memory, i.e. this value is lost when switching off the machine.

Structure Command  
“G” (General)

Byte	ASCII	Hex	Description
Master sends: <b>[M01G0Dsatttpp\r</b>			
1. Byte	[	5Bh	Start character
2. Byte	M	4Dh	Master ID
3. Byte	0	30h	Slave address
4. Byte	1	31h	Slave address
5. Byte	G	47h	Command qualifier
6. Byte	0	30h	Length of the command: 0Dh = 13 bytes (number of bytes without checksum and end character)
7. Byte	D	44h	
8. Byte	s: C / I / O / *	43h / 49h / 4Fh / 2Ah	Temperature control mode Meaning of the characters in the send string: “C” (43h) = Circulation, switch circulation on; “I” (49h) = Turn internal temperature control on; “O” (4Fh) = Off, turn temperature control off; “*” (2 Ah) = Do not change the current state.
9. Byte	a: 0 / 1 / *	30h / 31h / 2Ah	Alarm acknowledgment Meaning of the characters in the send string: “0” (30h) = No alarm acknowledgment; “1” (31h) = Any pending alarm tone is acknowledged; “*” (2 Ah) = Do not change the current state.
10. Byte	t	tttt / ****	Query or set the setpoint Meaning of the characters in the send string: Setpoint with 16-bit resolution (2 bytes, thus 4 ASCII characters) “tttt” = 0000h (0.00 °C) to 7FFFh (327.67 °C) FFFFh (-0.01 °C) to 8000h (-327.68 °C) 0190h corresponds to +4 °C, (30h, 31h, 39h, 30h) FE70h corresponds to -4 °C (46h, 45h, 37h, 30h) “****” (2Ah, 2Ah, 2Ah, 2Ah) = no change to the setpoint, setpoint is only queried
11. Byte	t		
12. Byte	t		
13. Byte	t		
14. Byte	p	Checksum	Checksum
15. Byte	p	Checksum	It is generated from bytes 1 to 13.
16. Byte	\r	0Dh	End character CR
The slave responds: <b>[S01G15satttiiiieepp\r</b>			
1. Byte	[	5Bh	Start character
2. Byte	C	53h	Slave ID
3. Byte	0	30h	Slave address
4. Byte	1	31h	Slave address
5. Byte	G	47h	Command qualifier
6. Byte	1	31h	Length of response: 15h = 21 Bytes
7. Byte	5	35h	
8. Byte	s: C / I / O	43h / 49h / 4Fh	Temperature control mode Meaning of the characters in the response string: “C” (43h) = Circulation, circulation is on; “I” (49h) = Internal temperature control is on; “O” (4Fh) = Off, temperature control is off.

Byte	ASCII	Hex	Description
9. Byte	a: 0 / 1	30h / 31h	Alarm status Meaning of the characters in the response string: "0" (30h) = No alarm; "1" (31h) = Any number other than "0" is an alarm
10. Byte	t	tttt / ****	Query or set the setpoint Meaning of the characters in the send string: Setpoint with 16-bit resolution (2 bytes, thus 4 ASCII characters) "tttt" = 0000h (0.00 °C) to 7FFFh (327.67 °C) FFFFh (-0.01 °C) to 8000h (-327.68 °C) 0190h corresponds to +4 °C, (30h, 31h, 39h, 30h) FE70h corresponds to -4 °C (46h, 45h, 37h, 30h) "****" (2Ah, 2Ah, 2Ah, 2Ah) = no change to the setpoint, setpoint is only queried
11. Byte	t		
12. Byte	t		
13. Byte	t		
14. Byte	i	iiii	Internal actual value Same format as setpoint
15. Byte	i		
16. Byte	i		
17. Byte	i		
18. Byte	e	eeee	External actual value Same format as setpoint, depends on device configuration
19. Byte	e		
20. Byte	e		
21. Byte	e		
22. Byte	p	Checksum	Checksum It is generated from bytes 1 to 21.
23. Byte	p	Checksum	
24. Byte	\r	0Dh	End character CR

**Example:**

The temperature control mode and the alarm status should remain unchanged (each "\*\*") and a setpoint of -4.00 °C (FE70) is to be set.

The master sends: **[M01G0D\*\*FE700A\r**

The slave responds (for example): **[S01G1500FE7009A4C504E7\r**

The temperature control unit is turned off ("O"), there is no alarm ("0"), the setpoint of -4.00 °C was set (FE70), the actual value is 24.68 °C (09A4), "C504" corresponds to -151.00 °C and indicates that no external temperature sensor is installed or connected.

### 6.3.2 PP commands

There is another set of commands to make the communication with the temperature control unit easy. The PP commands can be used, e.g. in conjunction with simple terminal programs. The calculation of a checksum has therefore been omitted and the commands kept very simple. Each command is terminated with Carriage Return ('\r', 0Dh) and Linefeed ('\n', 0Ah). There are read and write commands. Each correct command causes a response from the temperature control unit. Temperature and setpoint values are represented by a five-digit number, which corresponds to the temperature being expressed in hundredths of a degree (without decimal point).

Available read commands

Function	Master sends	Slave responds	Description
Read the setpoint	SP?\r\n	SP +02500\r\n	The setpoint is set to 25.00 °C.
Read the internal actual value	TI?\r\n	TI +02499\r\n	Currently, the internal actual value is 24.99 °C.
Read the external actual value	TE?\r\n	TE +02499\r\n	Currently, the external actual value is 24.99 °C.
		TE -15100\r\n	An external sensor is not connected or does not exist.
Read the temperature control mode	CA?\r\n	CA +00000\r\n	Temperature control and circulation are inactive.
		CA +00001\r\n	Temperature control and circulation are active.

Available write commands

Function	Master sends	Slave responds	Description
Setting the setpoint	SP@ -01234\r\n	SP -01234\r\n	The setpoint is set to -12.34 °C.
Starting the temperature control unit	CA@ 00001\r\n	CA +00001\r\n	The temperature control process is started.
Stopping the temperature control unit	CA@ 00000\r\n	CA +00000\r\n	The temperature control process is stopped.

## 7 Service/maintenance

### 7.1 Displays in the event of faults

An alarm signal (xx Hz) is sounded in the event of a fault and the temperature control unit displays an alarm or warning message on the OLED display.

Overview of messages

Code	Cause	Effect, measure
001	<b>Overtemperature alarm</b> The internal temperature is above the set value of the overtemperature protection. The overtemperature protection was triggered.	The internal temperature of the thermal fluid is in the upper allowable extreme range. The temperature control unit can be turned on again only when the temperature of the thermal fluid has returned to normal parameters. Check whether the thermal fluid used matches your required parameters if overtemperatures repeatedly shut down the unit.
002	<b>Tmax exceeded</b> The internal temperature is above the set setpoint limit.	The internal temperature of the thermal fluid is above the setpoint limit set in the controller. Control continues.
003	<b>Tmin undercut</b> The internal temperature is below the set setpoint limit.	The internal temperature of the thermal fluid is below the setpoint limit set in the controller. Control continues.
004	<b>Error float test</b>	Check the thermal fluid level. KISS: Is the float blocked or sticky? Please contact Customer Support if the thermal fluid level is sufficient and the float of the KISS controller moves freely.
005	<b>Low-level alarm</b> No enable signal, level alarm	Control is inactive. (Pump off, compressor off, heating off) Check the fill level of the thermal fluid. <b>Restart impossible until the thermal fluid level is OK.</b>
006	<b>Overpressure cutout triggered</b> The pressure in the condenser is too high. The overpressure cutout (pressure switch) has triggered.	Temperature and pressure increase in the condenser. An overpressure cutout (pressure switch) is installed to protect the temperature control unit against excessive pressure.  <b>Water cooling:</b> a.) Is the cooling water supply correctly connected? b.) Is the suction strainer (dirt trap) clogged? c.) What is the cooling water temperature, the cooling water flow rate and the cooling water pressure?  <b>Air cooling:</b> a.) Is the heat exchanger or the grille dirty? b.) Does the fan turn if the cooling machine is switched on? If the fan does not turn: Contact Customer Support.
009 011	<b>Sensor F1 short</b> <b>Sensor F2 short</b> Short-circuit at the internal temperature sensor F1 or at the external temperature sensor F2.	Control is inactive. (Pump off, compressor off, heating off) <b>Check the sensor.</b>
010 012	<b>Sensor F1 open</b> <b>Sensor F2 open</b> The internal temperature sensor F1 or the external temperature sensor F2 is open.	Control is inactive. (Pump off, compressor off, heating off) <b>Check the sensor.</b>



Code	Cause	Effect, measure
033	Error EP0 (Flash)	Please contact Customer Support.
034	Error EP1 (EEPROM)	
035	Error EP2 (NVRAM)	
036	Synchronization	
037	Parameters not equal	
038	Invalid status	
039	Error safety chip	
042	<b>Pump protection activated</b> The pump motor is overheated.	Check the ambient conditions. Check the viscosity of the thermal fluid. Turn the temperature control unit off and let it cool down.

## 7.2 Electrical fuse

The thermal overcurrent circuit breakers for all-pole disconnection (L and N) are located at the back. In case of a fault (no function and/or no display) please first check if the overcurrent circuit breakers have tripped. If the overcurrent circuit breakers trigger again immediately after reversing, please unplug the power cord and contact Customer Support immediately. → Page 57, section »Contact data«.

## 7.3 Maintenance



### Cleaning/maintenance while the temperature control unit is operating

#### MORTAL DANGER FROM ELECTRIC SHOCK

- Stop an ongoing temperature control process.
- Turn off the temperature control unit.
- Also disconnect the temperature control unit from the power supply.



### Performing maintenance work not described in these operation manual

#### MATERIAL DAMAGE ON THE TEMPERATURE CONTROL UNIT

- Please contact Huber for maintenance work that is not described in these operation manual.
- Maintenance work not described in these operation manual is reserved for qualified specialists trained by Huber.
- Safety-relevant components may only be replaced by equivalent ones. The specified safety values for the respective component must be observed.

### 7.3.1 Function check and visual inspection

Control intervals

Cooling*	Description	Maintenance interval	Comment	Person responsible
A/W	Visually inspect hoses and hose connections	Prior to switching on the temperature control unit	Exchange leaking hoses and hose connections prior to switching on the temperature control unit. → Page 50, section »Replacing temperature control or coolant hoses«.	Operating company and / or operators
A/W	Check the fill level in the collecting container at the >Overflow< [12] (if present)	Prior to switching on the temperature control unit	Check the fill level in the collecting container. Empty as required. Follow the instructions for the proper disposal of thermal fluid. → Page 15, section »Proper disposal of resources and consumables«.	Operating company and / or operators
A/W	Check the power cable	Prior to switching on the temperature control unit or on relocation	Do not start the temperature control unit if the power supply cable is damaged.	Qualified electrician (BGV A3)

Cooling*	Description	Maintenance interval	Comment	Person responsible
A/W	Thermal fluid inspection	As required	–	Operating company and / or operators
A/W	Overtemperature protection (OT) - functional check	Every month or after changing the thermal fluid	→ Page 36, section » <b>Testing overtemperature protection for functionality</b> «.	Operating company and / or operators
A/W	Check the temperature control unit for damage and stability	Every 12 months or after a change of location	–	Operating company and / or operators
W	Check the cooling water quality	Every 12 months	Descale the cooling water circuit as required. Documentation on water quality is available at: <a href="http://www.huber-online.com">www.huber-online.com</a>	Operating company and / or operators
A/W	Exchange safety-relevant electric and electromechanical components	20 years	Have the exchange only carried out by certified personnel (such as Huber service engineers). Please contact Customer Support. → Page 57, section » <b>Contact data</b> «.	Operating company

\*A = Air cooling; W = Water cooling; U = Applicable only for Unistats

## 7.3.2 Replacing temperature control or coolant hoses

Replace defective temperature control and/or coolant hoses **before** turning on the temperature control unit.

### 7.3.2.1 Replacing temperature control hoses

#### PROCEDURE

- Drain the temperature control unit. → Page 38, section »**Draining the bath thermostat**«.
- Replace defective temperature control hoses. Follow the instructions for the proper disposal. → Page 15, section »**Proper disposal of resources and consumables**«.
- Reconnect your external application. → Page 26, section »**Connecting externally closed application**«.
- Fill the temperature control unit with thermal fluid. → Page 37, section »**Filling and venting the bath thermostat and the externally closed application**«.
- Vent the temperature control unit. → Page 37, section »**Filling and venting the bath thermostat and the externally closed application**«.
- Restart the temperature control unit in normal mode.

### 7.3.2.2 Replacing coolant hoses

#### PROCEDURE

- Drain the cooling water. → Page 55, section »**Draining the cooling water**«.
- Replace the defective coolant hoses. Follow the instructions for the proper disposal. → Page 15, section »**Proper disposal of resources and consumables**«.
- Reconnect the temperature control unit to the building's cooling water supply. → Page 23, section »**Temperature control units with cooler**«.
- Restart the temperature control unit in normal mode.

## 7.4 Thermal fluid inspection, replacement and circuit cleaning

Observe the wiring diagram. → From page 58, section »Annex«.

### CAUTION

#### Extremely hot / cold surfaces, connections and thermal fluids

##### BURNS/FREEZING OF LIMBS

- Surfaces, connections and tempered thermal fluids can be extremely hot or cold depending on the operating mode.
- Avoid direct contact with surfaces, connections and thermal fluids!
- Wear your personnel protective equipment (e.g. temperature-resistant safety gloves, safety goggles).

### NOTE

#### During an active circulation, the thermal fluid circuit is shut off by shut-off valves

##### MATERIAL DAMAGE TO THE CIRCULATING PUMPS INSTALLED IN THE TEMPERATURE CONTROL UNIT

- Do not close the thermal fluid circuit during an active circulation by means of shut-off valves.
- Warm the thermal fluid to room temperature before stopping the circulation.

### 7.4.1 Thermal fluid inspection

### CAUTION

#### Thermal fluid is not inspected on a regular basis

##### BURNS DUE TO REDUCED BOILING POINT

- Regularly check your thermal fluid whether it meets the specifications in the safety data sheet.

### NOTE

#### Thermal fluid is not inspected on a regular basis

##### DAMAGE TO THE HEAT EXCHANGER AND/OR ELECTROMECHANICAL PARTS.

- Regularly check your thermal fluid whether it meets the specifications in the safety data sheet.

### INFORMATION

#### Oxidation

Oxidation ages the thermal fluid and change its characteristics (e.g. a reduced boiling point). When controlling high temperatures, a reduced boiling point may cause overflow of very hot thermal fluids. It may cause serious burns of the limbs.

#### Hygroscopy

When continuously thermoregulating below room temperature, hygroscopy causes the thermal fluid to accumulate water in the course of time. Such a liquid mixture causes the evaporator to burst when thermoregulating in the minus range. This is caused by the water in the liquid mixture, which forms ice crystals on the evaporator. When thermoregulating high temperatures with such a liquid mixture, the boiling point is reduced. When controlling high temperatures, a reduced boiling point may cause overflow of very hot thermal fluids. It may cause serious burns of the limbs. Hygroscopy can change the mixing ratio of a water-ethylene-glycol mixture.

### 7.4.2 Rinsing the thermal fluid circuit

### DANGER

#### Setpoint and overtemperature protection are not adjusted to the thermofluid

##### MORTAL DANGER FROM FIRE

- The cut-out value of the overtemperature protection **must** be adapted to the thermofluid. Set the cut-out value of the overtemperature protection 25 K below the fire point of the thermofluid.
- The setpoint set during rinsing **must** be adjusted to the thermofluid used.

### CAUTION

#### Non-compliance with the safety data sheet for the thermal fluid to be used

##### INJURIES

- Risk of injury to the eyes, skin, respiratory tract.
- The safety data sheet for the thermal fluid to be used must be read prior to using it and its content must be respected.
- Observe the local regulations/work instructions.
- Wear your personal protective equipment (e.g. temperature-resistant safety gloves, safety goggles, safety footwear).
- Danger of slipping because floor and work area are contaminated. Clean the workplace; observe the proper disposal of thermal fluid and aids. → Page 15, section »Proper disposal of resources and consumables«.

**NOTE**

**Mixing different thermofluids in a thermal fluid circuit**

**PROPERTY DAMAGE**

- Do **not** mix different types of thermofluid (such as mineral oil, silicone oil, synthetic oil, water, etc.) in a thermofluid circuit.
- The thermal fluid circuit **must** be rinsed when changing from one type of thermal fluid to another. No residues of the previous type of thermal fluid may remain in the thermal fluid circuit.

Example: Connecting a short circuit hose

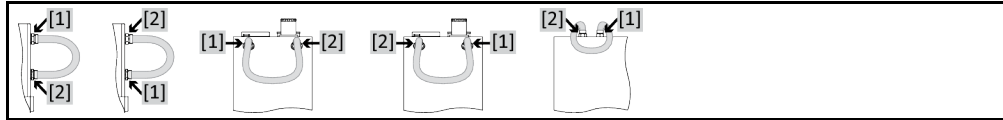

The inner components of the temperature control unit must be dried out. Need to avoid boiling retardation during future uses (e.g. use of a silicone oil at temperatures above about 100 °C).

**PROCEDURE**

- Drain the temperature control unit. → Page 38, section »**Draining the bath thermostat**«.

**INFORMATION**

Residual thermal fluid can remain in the pump chamber and the internal lines after draining. Leave the temperature control unit with open valves for a while.

- Leave the drain hose mounted to the >Drain< [8].
- Check the fill level in the collecting container at the other end of the drain hose. Follow the instructions for the proper disposal of thermal fluid. → Page 15, section »**Proper disposal of resources and consumables**«.
- Close the drain valves on the temperature control unit by turning them clockwise (turn 90° right as far as they will go).
- Connect the >Circulation flow< [1] with the >Circulation return< [2] at the temperature control using a bypass hose.

**INFORMATION**

Perform the following steps without attaching a short circuit hose, if the application used by you (externally closed) is also dirty. In this case, leave your externally closed application connected to the temperature control unit. This rinses the temperature control unit and your application at the same time.

- **Fill** the system (minimum fill level) with the thermal fluid you wish to use. → Page 37, section »**Filling and venting the bath thermostat and the externally closed application**«.
- **Vent** the system. → Page 37, section »**Filling and venting the bath thermostat and the externally closed application**«.
- Adjust the **setpoint** and the cut-out value of the **overtemperature protection** to the thermal fluid used. → Page 34, section »**Setting the setpoint**« and → Page 35, section »**Setting the overtemperature (OT) protection**«.
- **Start** the **circulation**. → Page 40, section »**Starting the temperature control process**«. The length of rinsing depends on the level of soiling.
- **Stop** the **circulation**. → Page 40, section »**Ending the temperature control process**«.
- **Drain** the temperature control unit. → Page 37, section »**Filling and venting the bath thermostat and the externally closed application**«.
- Repeat the steps “Filling”, “Venting”, “Start/Stop circulation” and “Draining” until the drained thermal fluid remains clear.
- Remove the bypass hose after completely draining the temperature control unit.

**INFORMATION**

Leave an application connected, if you have simultaneously rinsed a used application (externally closed).

- Leave the >Drain< [8] open for a while to allow the thermal fluid remaining in the temperature control unit to evaporate.
- Close the >Drain< [8] once the residual thermal fluid has evaporated.
- Dismount the drain hose.
- Remove the collecting container.
- Dispose of the collecting container, including its contents. Follow the instructions for the proper disposal. → Page 15, section »**Proper disposal of resources and consumables**«.
- Re-connect your application. (Only if you have rinsed the thermal fluid circuit using a bypass hose.)

- Fill the temperature control unit with thermal fluid. → Page 37, section »Filling and venting the bath thermostat and the externally closed application«.
- Vent the temperature control unit. → Page 37, section »Filling and venting the bath thermostat and the externally closed application«. An externally open application does not need to be vented.
- Start the function „Degassing“. → Page 38, section »Degassing of bath thermostat«. An externally open application does not need to be de-gassed.
- Restart the temperature control unit in normal mode.

## 7.5 Cleaning the surfaces

### CAUTION

#### Extremely hot / cold surfaces, connections and thermal fluids BURNS/FREEZING OF LIMBS

- Surfaces, connections and tempered thermal fluids can be extremely hot or cold depending on the operating mode.
- Avoid direct contact with surfaces, connections and thermal fluids!
- Wear your personnel protective equipment (e.g. temperature-resistant safety gloves, safety goggles).

### NOTE

#### Exposed plug contacts DAMAGE CAUSED BY FLUID INGRESS

- Protect unused plug contacts with the protective caps supplied.
- Clean surfaces only with a damp cloth.

A standard stainless steel cleaning agent is suitable for cleaning the stainless steel surfaces. Carefully clean painted surfaces (damp only) using a solution of sensitive-fabrics detergent. Observe the proper disposal of thermal fluid and aids. → Page 15, section »Proper disposal of resources and consumables«.

## 7.6 Plug contacts

### NOTE

#### Exposed plug contacts DAMAGE CAUSED BY FLUID INGRESS

- Protect unused plug contacts with the protective caps supplied.
- Clean surfaces only with a damp cloth.

Protective caps are supplied for all plug contacts. Make sure that any plug contacts not required are protective with the caps.

## 7.7 Decontamination/repairs

### CAUTION

#### Returning a not decontaminated temperature control unit for repair PHYSICAL INJURY AND PROPERTY DAMAGE CAUSED BY HAZARDOUS MATERIALS IN OR ON THE TEMPERATURE CONTROL UNIT

- Carry out appropriate decontamination.
- The decontamination process depends on the type and quantity of the materials used.
- Consult the relevant safety data sheet.
- You will find a prepared return receipt at [www.huber-online.com](http://www.huber-online.com).

As the responsible body you are responsible for carrying out decontamination **before** third-party personnel come into contact with the temperature control unit / accessory. Decontamination must be carried out **before** the temperature control unit / accessory is returned for repair or inspection. Attach a clearly visible written notice stating that the temperature control unit / accessory has been decontaminated.

To simplify the process, we have prepared a form for you. This is available for download at [www.huber-online.com](http://www.huber-online.com).

## 8 Shutting down

### 8.1 Safety instructions and basic principles



**DANGER**

**Connection/adjustment to the power supply not carried out by an electrician and/or connection to a power socket without protective earth (PE)**

**MORTAL DANGER FROM ELECTRIC SHOCK**

- Have the connection/adjustment to the power supply carried out by an electrician.
- Always connect the temperature control unit to safety sockets (PE).



**DANGER**

**Damaged power cable/power cable connection**

**MORTAL DANGER FROM ELECTRIC SHOCK**

- Do not start up the temperature control unit.
- Isolate the temperature control unit from the power supply.
- Have the power supply cable/power supply connection replaced and inspected by an electrician.
- Do not use a power cable that is longer than **3 m**.



**WARNING**

**Risk of tipping due to unstable temperature control unit**

**SERIOUS INJURY AND PROPERTY DAMAGE**

- Avoid risk of tipping due to unstable temperature control unit.



**CAUTION**

**Non-compliance with the safety data sheet for the thermal fluid to be used**

**INJURIES**

- Risk of injury to the eyes, skin, respiratory tract.
- The safety data sheet for the thermal fluid to be used must be read prior to using it and its content must be respected.
- Observe the local regulations/work instructions.
- Wear your personal protective equipment (e.g. temperature-resistant safety gloves, safety goggles, safety footwear).
- Danger of slipping because floor and work area are contaminated. Clean the workplace; observe the proper disposal of thermal fluid and aids. → Page 15, section »**Proper disposal of resources and consumables**«.



**CAUTION**

**Hot or very cold thermal fluid**

**SEVERE BURNS/FROSTBITE OF LIMBS**

- Before draining, ensure that the thermal fluid has room temperature (20 °C).
- If, at this temperature, the thermal fluid is too viscous to be drained: Control the temperature of the thermal fluid for a few minutes until the viscosity will allow drainage. Never control the temperature of the thermal fluid when the drain is open.
- Danger of burns when draining thermal fluids at temperatures above 20 °C.
- Wear your Personal Protective Equipment for draining.
- Only drain using suitable drainage hose and collecting container. These must be compatible with the thermal fluid and its temperature.

**INFORMATION**

All safety instructions are important and must be followed accordingly during working operations!

### 8.2 Switch-off

#### PROCEDURE

- Turn off the temperature control unit.
- Disconnect the temperature control unit from the power supply connection.

### 8.3 Draining the temperature control unit

#### PROCEDURE

- Drain the temperature control unit. → From page 37, section »Filling, venting, degassing and draining«.

### 8.4 Draining the cooling water

#### INFORMATION

This section must be observed when using water-cooled temperature control units.

#### 8.4.1 Draining process

#### CAUTION

**Pressurized cooling water connections**

##### RISK OF INJURY

- Wear your personnel protective equipment (e.g. safety goggles).
- Carefully open the cooling water connection. Open slowly (1-2 signal edges) and drain the cooling water slowly.

#### NOTE

**Building side isolating valves are not closed**

##### DAMAGE BY ROOM FLOODING

- Close the building's isolating valves in the cooling water supply and return lines.

#### PROCEDURE

- Close the isolating valves in the water supply on the temperature control unit (if present) and on the building side.
- Place a collecting container below the inlet and outlet of the >Cooling coil< [29].
- Undo the connections on the >Cooling coil< [29]. The cooling water will begin to drain out of the lines.
- Remove the cooling water from the >Cooling coil< [29]. Allow all the cooling water to drain out completely to prevent the risk of freezing during transport and storage!

### 8.5 Deinstalling the collecting container

#### PROCEDURE

- Remove the hose from the collecting container.
- Follow the instructions for the proper disposal of thermal fluid. → Page 15, section »Proper disposal of resources and consumables«.
- Dismantle the hose at the >Overflow< [12].

### 8.6 Uninstalling an external application

#### PROCEDURE

- Disconnect the external application from the temperature control unit.

### 8.7 Packing

Always use the original packaging! → Page 20, section »Unpacking«.

## 8.8 Shipping

**NOTE**

**Temperature control unit transported incorrectly**

**PROPERTY DAMAGE**

- Do not transport by truck on the castors or feet.
- Comply all requirements in this section to avoid damage to the temperature control unit.

Pallet with squared timber for free-standing units

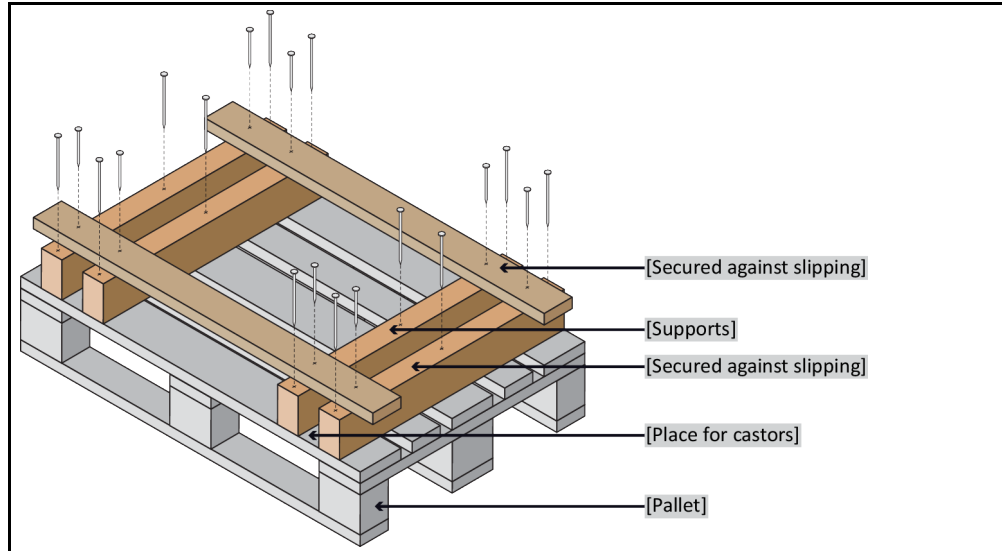

Transport using the lugs, if fitted, on the top of the temperature control unit. Do not transport the temperature control unit alone and without aids.

- Always use the original packaging for transportation.
- Indicate the upright transport position with arrows on the packaging.
- Always transport the temperature control unit upright on a pallet!
- Protect attachments from damage during transportation!
- During transport, place the temperature control unit on squared timber to protect the casters/feet.
- Secure with tensioning belts/lashing straps that are suitable for the weight.
- Additionally secure (depending on model) with plastic film, cardboard and straps.

## 8.9 Disposal

**NOTE**

**Improper disposal**

**ENVIRONMENTAL DAMAGE**

- Spilled/leaked thermal fluid must be discarded immediately and correctly. Observe the proper disposal of thermal fluid and aids. → Page 15 the section »**Proper disposal of resources and consumables**«.
- To avoid environmental damage, have “disused” temperature control units disposed of exclusively by approved waste management companies (e.g. refrigeration and air conditioning companies).

Huber temperature control units and Huber accessories are made of high quality, recyclable materials. For example: Stainless steel 1.4301 / 1.4401 (V2A), copper, nickel, FKM, Perbunan, NBR, ceramic, carbon, Al-Oxid, red brass, brass, nickel-plated brass and silver solder. Proper recycling of the temperature control unit and accessories can actively help reduce CO<sub>2</sub> emissions in the production of these materials. Follow the laws and regulations of your jurisdiction when disposing material.



## 8.10 Contact data

### INFORMATION

Contact your supplier or local specialist retailer **prior** to returning the temperature control unit. The contact data can be found on our homepage [www.huber-online.com](http://www.huber-online.com) under the heading „Contact“. Please keep the serial number of the temperature control unit ready. The serial number can be found on the nameplate of the temperature control unit.

### 8.10.1 Telephone number: Customer Support

If your country is not mentioned in the list below: The responsible service partner can be found on our homepage [www.huber-online.com](http://www.huber-online.com) under the heading „Contact“.

- Huber Deutschland: +49 781 9603 244
- Huber China: +86 (20) 89001381
- Huber India: +91 80 2364 7966
- Huber Ireland: +44 1773 82 3369
- Huber Italia: +39 0331 181493
- Huber Swiss: +41 (0) 41 854 10 10
- Huber UK: +44 1773 82 3369
- Huber USA: +1 800 726 4877 | +1 919 674 4266

### 8.10.2 Telephone number: Sales

Telephone: +49-781-9603-123

### 8.10.3 Email address: Customer Support

Email: [support@huber-online.com](mailto:support@huber-online.com)

## 8.11 Certificate of Compliance

This certificate must be enclosed with the temperature control unit. → Page 53, section »**Decontamination/repairs**«.

## 9 Annex



# Inspired by **temperature** designed for you

Peter Huber Kältemaschinenbau SE  
Werner-von-Siemens-Str. 1  
77656 Offenburg / Germany

Telefon +49 (0)781 9603-0  
Telefax +49 (0)781 57211

[info@huber-online.com](mailto:info@huber-online.com)  
[www.huber-online.com](http://www.huber-online.com)

Technischer Service: +49 (0)781 9603-244

-125 °C ... +425 °C

**huber**