

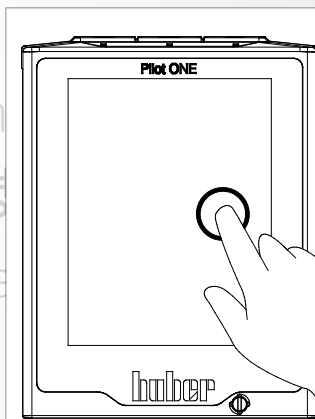

Inspired by temperature

Betriebsanleitung · Operation manual · Manual de instrucciones · Manuel d'utilisation · Manuale de d'uso · 사용 설명서 · Manual de instruções · Инструкция по эксплуатации · Kullanım talimatı · 操作说明书



BFT[®]
Beer-Force-
Ageing-Test
Bath

Betriebsanweisung · Manual de instrucciones · 사용 설명서 · Инструкция по эксплуатации · Kullanım talimatı · 操作说明书 · Manual de instrucciones · Manual de d'uso · Инструкция по эксплуатации · 操作说明书 · Manual de instrucciones · Manual de d'uso

· 사용 설명서 · Manual de instruções · Инструкция по эксплуатации · Kullanım talimatı · 操作说明书

This documentation does not contain a device-specific technical appendix.

You can request the full operating instructions from info@huber-online.com. Please give the model designation and serial number of your temperature control unit in your e-mail.

huber



OPERATION MANUAL

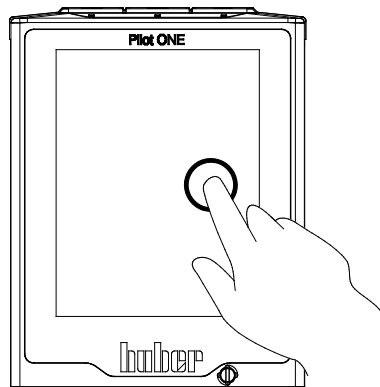

BFT[®]
Beer-Force-
Ageing-Test
Bath

BFT®

Pilot ONE®

This operation manual is a translation of the original operation manual.

VALID FOR:

BFT®

Abbreviations used in model names:
without = air cooled, w = water cooled

„Pilot ONE“

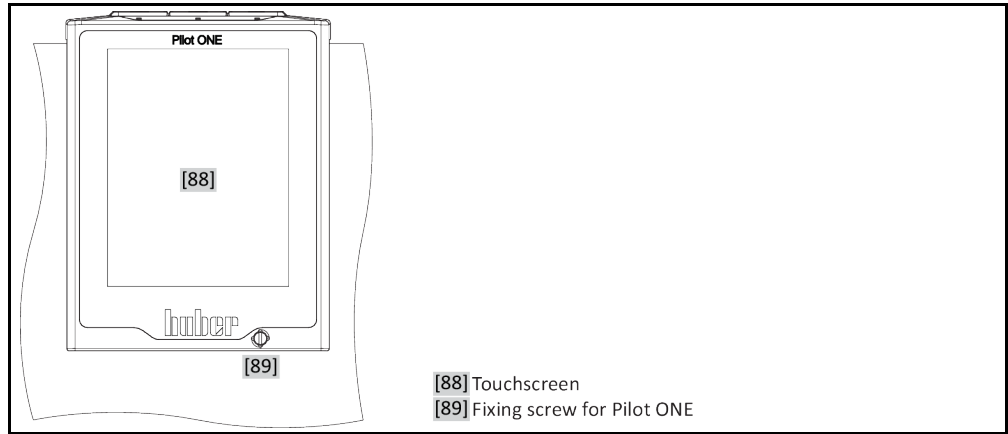

- [88] Touchscreen
- [89] Fixing screw for Pilot ONE

Layout of the "Home" screen

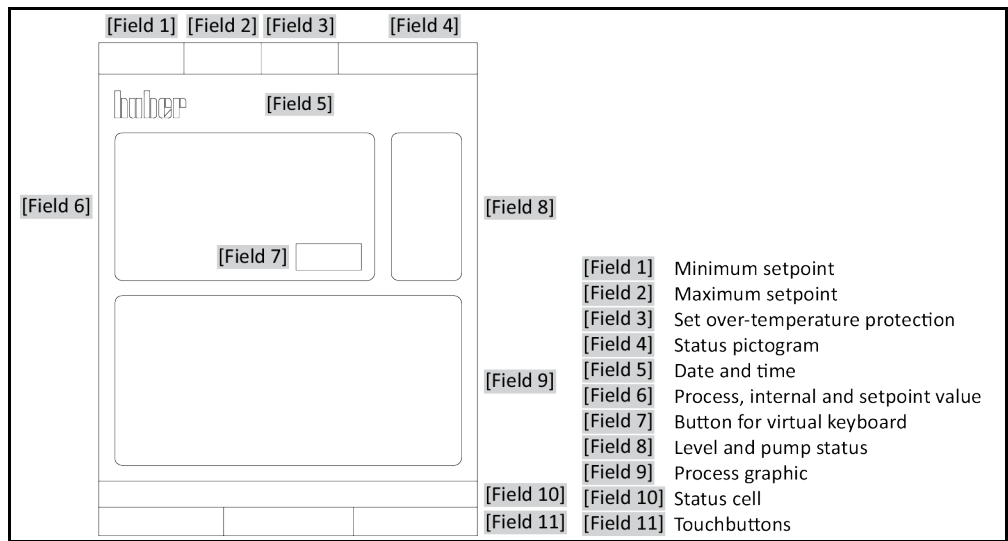

- [Field 1] Minimum setpoint
- [Field 2] Maximum setpoint
- [Field 3] Set over-temperature protection
- [Field 4] Status pictogram
- [Field 5] Date and time
- [Field 6] Process, internal and setpoint value
- [Field 7] Button for virtual keyboard
- [Field 8] Level and pump status
- [Field 9] Process graphic
- [Field 10] Status cell
- [Field 11] Touchbuttons

Table of contents

V2.5.0en/21.02.22//17.12

1	Introduction	12
1.1	Identification / symbols in the operation manual	12
1.2	Information on the EU Declaration of Conformity	12
1.3	Safety	12
1.3.1	Symbols used for Safety Instructions	12
1.3.2	Representation of safety identifiers on the temperature control unit	13
1.3.3	Proper operation	13
1.3.4	Reasonably foreseeable misuse	14
1.4	Responsible bodies and operators – Obligations and requirements	14
1.4.1	Obligations of the responsible body	14
1.4.1.1	Proper disposal of resources and consumables	15
1.4.1.2	Temperature control unit with natural refrigerants (NR)	15
1.4.1.3	Temperature control units with fluorinated greenhouse gases/refrigerants	17
1.4.2	Requirements for operators	18
1.4.3	Obligations of the operators	18
1.5	General information	18
1.5.1	Description of workstation	18
1.5.2	Safety devices to DIN 12876	18
1.5.3	Further protective devices	19
1.5.3.1	Power interruption	20
1.5.3.2	Alarm functions	20
1.5.3.3	Warning messages	20
2	Commissioning	21
2.1	In-plant transport	21
2.1.1	Lifting and transporting the temperature control unit	21
2.1.1.1	Temperature control unit with lifting eyes	21
2.1.1.2	Temperature control unit without lifting eyes	22
2.1.2	Mounting/removing leveling feet	22
2.1.3	Positioning the temperature control unit	23
2.1.3.1	Temperature control unit with casters	23
2.1.3.2	Temperature control unit without casters	23
2.2	Unpacking	23
2.3	Ambient conditions	23
2.3.1	EMC-specific notes	25
2.4	Installation conditions	25
2.5	Recommended cooling water hoses	25
2.6	Wrench sizes and torques	26
2.7	Temperature control units with water cooling	26
2.8	Temperature control unit with batch	28
2.8.1	Operation as bath thermostat	28
2.9	Preparations for operation	28
2.9.1	Unscrewing/activating the leveling feet (if any)	28
2.9.2	Opening/closing valves	28
2.9.3	Connecting the functional earth	28
2.10	Connecting to the power supply	29
2.10.1	Connection using socket with protective earth (PE)	29

2.10.2	Connection via hard wiring	29
3	Function description	30
3.1	Function description of the temperature control unit	30
3.1.1	General functions.....	30
3.1.2	Other functions.....	30
3.2	Information on the thermal fluids	30
3.3	To be noted when planning the test	31
3.4	“Pilot ONE®” controller	32
3.4.1	Functional overview of “Pilot ONE®”	32
3.5	Clock/event function.....	34
3.5.1	Rechargeable accumulator	34
3.5.2	Programmable event function	34
3.5.2.1	Event function “Alarm clock event”	34
3.5.2.2	Event function “Program event”	34
3.6	Operation via the touch screen.....	34
3.7	Display instruments	35
3.7.1	The touchscreen [88]	35
3.8	Control instruments	35
3.8.1	The touchbuttons.....	36
3.8.2	The categories.....	36
3.8.3	The sub-categories.....	36
3.8.4	The dialogs	36
3.9	Function examples	36
3.9.1	Display of software version.....	36
3.9.2	Start & Stop.....	37
3.9.3	Copying the settings to a data carrier	37
3.9.3.1	Saving to a USB flash drive	37
3.9.3.2	Loading from a USB flash drive.....	38
3.9.4	Restore factory settings	38
3.9.4.1	Restore to factory settings without overtemperature protection	39
3.9.4.2	Restore to factory settings including overtemperature protection	39
4	Setup mode	41
4.1	Setup mode	41
4.1.1	Turning on the temperature control unit	41
4.1.2	Turning off the temperature control unit.....	41
4.1.3	Setting the overtemperature protection	42
4.1.3.1	General information on the overtemperature protection	42
4.1.3.2	Setting “OT limit: heating”	42
4.1.3.3	Setting “Process Safety”	43
4.1.3.4	Monitoring via “Display OT values”	43
4.1.4	Testing overtemperature protection for functionality	43
4.2	The temperature control circuit.....	44
4.2.1	Selecting the temperature control: Internal.....	44
4.2.2	Temperature control to internal temperature	44
4.2.3	Optimum control parameters for optimum temperature control.....	45
4.2.4	Sub-category: “Select auto/expert mode”	45
4.2.5	Sub-category: “Configuration auto”	45
4.2.5.1	Sub-category: “Find parameters”	45
4.2.5.2	Sub-category: “Control Dynamics”	47
4.2.5.3	Sub-category: “Fluid Properties”	48
4.2.5.4	Sub-category: “Display parameters”	49

4.2.6	Sub-category: "Configuration manual"	49
4.2.6.1	Sub-category: "Change parameters"	49
4.2.6.2	Sub-category: "Display parameters"	50
4.2.6.3	Sub-category: "Control structure"	50
4.2.7	Sub-category: "Reset parameters"	50
4.2.8	Sub-category: "Display parameters"	51
4.2.9	Freeze protection for temperature control unit	51
4.2.10	Setting the setpoint thresholds	51
4.2.11	Setting the setpoint	52
4.3	Filling and draining	52
4.3.1	Filling and draining of bath thermostat	53
4.3.1.1	Filling of bath thermostat	53
4.3.1.2	Draining the bath thermostat	54
5	Normal operation	55
5.1	Automatic operation	55
5.1.1	Temperature control	55
5.1.1.1	Starting the temperature control process	55
5.1.1.2	Ending the temperature control process	55
5.1.2	Temperature control via a created temperature control program	56
5.1.2.1	Starting the temperature control program	56
5.1.2.2	Ending/cancelling the temperature control program	56
5.1.3	Temperature control via beer force ageing test program	56
5.1.3.1	Start beer force ageing test	56
5.1.3.2	Stop/cancel beer force ageing test program	57
6	Interfaces and software update	58
6.1	Interfaces at the "Pilot ONE®" controller	58
6.1.1	10/100 Mbps Ethernet for RJ45 network sockets	58
6.1.2	USB-2.0 interface	59
6.1.2.1	USB-2.0 interface, host	59
6.1.2.2	USB-2.0 interface, device	59
6.2	Interfaces at the back	59
6.2.1	Service interface	59
6.2.2	RS232 (option) / activation of cooling bath	59
6.3	Firmware update	59
7	Service/maintenance	60
7.1	Messages from the temperature control unit	60
7.2	Electrical fuse	60
7.3	Replacing the "Pilot ONE®"	60
7.4	Maintenance	61
7.4.1	Function check and visual inspection	61
7.4.2	Replacing coolant hoses	62
7.4.3	Clean liquefier fins (air-cooled temperature control unit)	62
7.4.4	Clean hat-type strainer (dirt trap) (water-cooled temperature control unit)	63
7.5	Thermal fluid inspection, replacement and circuit cleaning	63
7.5.1	Thermal fluid inspection	63
7.5.2	Rinsing the thermal fluid circuit	64
7.6	Cleaning the surfaces	65
7.7	Plug contacts	65
7.8	Decontamination/repairs	65

8	Shutting down	67
8.1	Safety instructions and basic principles	67
8.2	Switch-off	68
8.3	Draining the temperature control unit.....	68
8.4	Draining the cooling water	68
8.4.1	Draining process	68
8.5	Uninstalling an external application	69
8.6	Packing	69
8.7	Shipping.....	69
8.8	Disposal	70
8.9	Contact data	70
8.9.1	Telephone number: Customer Support	70
8.9.2	Telephone number: Sales	70
8.9.3	Email address: Customer Support.....	70
8.10	Certificate of Compliance	70
9	Annex	71

Foreword

Dear Customer,

Thank you for choosing a temperature control unit from Peter Huber Kältemaschinenbau SE. You have made a good choice. Thank you for your trust.

Please read the operation manual carefully before putting the unit into operation. Strictly follow all notes and safety instructions.

Follow the operation manual with regard to transport, start-up, operation, maintenance, repair, storage and disposal of the temperature control unit.

We fully warrant the temperature control unit for the specified intended operation.

The models listed on page 5 are referred to in this operation manual as temperature control units and Peter Huber Kältemaschinenbau SE as Huber company or Huber.

Liability for errors and misprints excluded.

The following trademarks and the Huber logo are registered trademarks of Peter Huber Kältemaschinenbau SE in Germany and/or other countries worldwide: BFT®, CC®, Chili®, Com.G@te®, Compatible Control®, CoolNet®, DC®, E-grade®, Grande Fleur®, Huber Piccolo®, KISS®, Minichiller®, Ministat®, MP®, MPC®, Peter Huber Minichiller®, Petite Fleur®, Pilot ONE®, RotaCool®, Rotostat®, SpyControl®, SpyLight®, Tango®, TC®, UC®, Unical®, Unichiller®, Unimotive®, Unipump®, Unistat®, Unistat Tango®, Variostat®. The following trademarks are registered in Germany to DWS Synthesetechnik: DW-Therm®, DW-Therm HT®. The following trademark is a registered trademark of BASF SE: Glystantin®.

1 Introduction

1.1 Identification / symbols in the operation manual

The following identifications and symbols are used in the texts and illustrations.

Overview	Identification / symbol	Description
	→	Reference to information / procedure.
	»TEXT«	Reference to a chapter in the operation manual. In the digital version, the text is clickable.
	>TEXT< [NUMBER]	Reference to the wiring diagram in the annex. The designation and the search digit are specified.
	>TEXT< [LETTER]	Reference to a drawing in the same paragraph. The designation and the search digit are specified.
	▪	List, first level
	–	List, second level

1.2 Information on the EU Declaration of Conformity





 The equipment complies with the basic health and safety requirements of the European Directives listed below:

- Machinery Directive
- Low Voltage Directive
- EMC Directive

1.3 Safety

1.3.1 Symbols used for Safety Instructions

Safety instructions are marked by the below combinations of pictograms and signal words. The signal word describes the classification of the residual risk when disregarding the operation manual.

	Denotes an immediate hazardous situation that will result in death or serious injuries.
	Denotes a general hazardous situation that may result in death or serious injuries.
	Denotes a hazardous situation that can result in injury.
	Denotes a situation that can result in property material damage.
	Denotes important notes and usable hints.



Notes in conjunction with Ex px cabinets.

Safety information and procedure

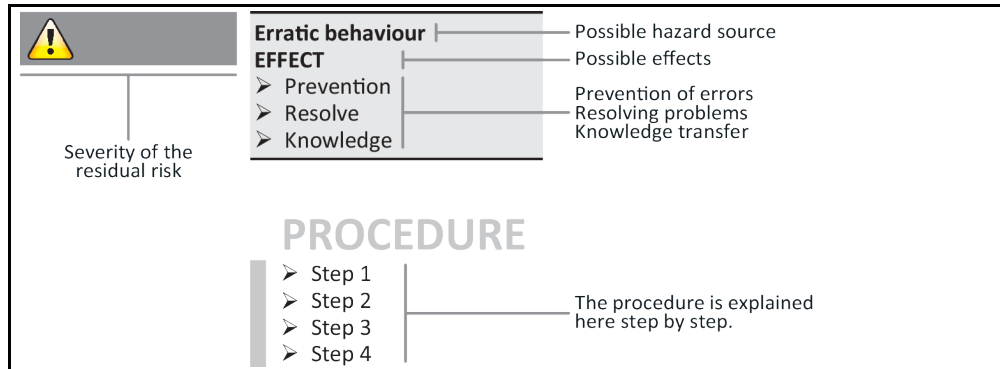

The safety information in this operation manual is designed to protect the operating company, the operator and the equipment from damage. First inform yourself about any residual risks due to misuse before you start an operation.

1.3.2 Representation of safety identifiers on the temperature control unit

The following pictograms are used as safety identifiers. The table gives an overview of the safety identifiers used here.

Identifier	Description
Mandatory sign	
	- Observe the instructions
Warning sign	
	- General warning sign - Observe the instructions
	- Warning of electrical voltage
	- Warning of hot surface
	- Warning of flammable substances

1.3.3 Proper operation



Operating the temperature control unit in a potentially explosive area

DEATH THROUGH EXPLOSION

- Do NOT install or start up the temperature control unit within an ATEX zone.

WARNING**Improper use****SERIOUS INJURY AND PROPERTY DAMAGE**

- Store the operation manual where it is easy to access in close proximity to the temperature control unit.
- Only adequately qualified operators may work with the temperature control unit.
- Operators must be trained before handling the temperature control unit.
- Check that the operators have read and understood the operation manual.
- Define precise responsibilities of the operators.
- Personal protective equipment must be provided to the operators.
- Be sure to follow the responsible body's safety rules to protect life and limb and to limit damages!

NOTE**Modifications to the temperature control unit by third-parties****DAMAGE TO THE TEMPERATURE CONTROL UNIT**

- Do not allow third parties to make technical modifications to the temperature control unit.
- The EU declaration of conformity becomes invalid if any modifications are made to the temperature control unit without the approval of Huber.
- Only specialists trained by Huber may carry out modifications, repairs or maintenance work.
- **The following must be observed without fail:**
- Only use the temperature control unit in a fault-free condition!
- Have the start-up and repairs carried out by specialists only!
- Do not ignore, bypass, dismantle or disconnect any safety devices!

The temperature control unit must not be used for any purposes other than temperature control in accordance with the operation manual.

The temperature control unit is made for industrial use. The temperature control unit is used to maintain the temperature of applications, such as glass or metal reactors or other expedient items in laboratories and industry. Flow-through coolers and calibration baths must be used only in combination with Huber temperature control units. Only use thermal fluids suitable for the overall system. The cooling or heating capacity is provided at the pump connections or - where present - in the tempering bath. For the technical specification, refer to the datasheet. → From page 71, section »Annex«. Install, set up and operate the temperature control unit according to the instructions in this operation manual. Any failure to comply with the operation manual is considered as improper operation. The temperature control unit was manufactured according to the state of the art and the recognized safety rules and regulations. Safety devices are installed in your temperature control unit.

1.3.4 Reasonably foreseeable misuse



Without an Ex px cabinet, the temperature control unit / accessory is **NOT** protected against explosion and must **NOT** be installed or put into operation within an ATEX Zone. When operating the temperature control unit /accessory in conjunction with an Ex px cabinet, the information in the annex (Section ATEX operation) must be observed and followed. This annex is only provided for temperature control units /accessories delivered with an Ex px cabinet. If this annex is missing, please immediately contact the Customer Support. → Page 70, section »Contact data«.

Use with medical devices (e.g. in Vitro diagnostic procedure) or for direct foodstuff temperature control is **NOT** permissible.

The temperature control unit must **NOT** be used for any purposes other than temperature control in accordance with the operation manual.

The manufacturer accepts **NO** liability for damage caused by **technical modifications** to the temperature control unit, **improper handling** or use of the temperature control unit if the operation manual is **not observed**.

1.4 Responsible bodies and operators – Obligations and requirements

1.4.1 Obligations of the responsible body

The operation manual is to be stored where it is easy to access in close proximity to the temperature control unit. Only adequately qualified operators (e.g. chemists, CTA, physicists etc.) are permitted to

work with the temperature control unit. Operators must be trained before handling the temperature control unit. Check that the operators have read and understood the operation manual. Define precise responsibilities of the operators. Personal protective equipment must be provided to the operators.

- The responsible body must install a condensation water / thermal fluid drip tray below the temperature control unit.
- The use of a drip tray may be prescribed by national legislation for the installation area of the temperature control unit (incl. accessory). The responsible body must check and apply the national regulations applicable for it accordingly.
- The temperature control unit complies with all applicable safety standards.
- Your system, which uses our temperature control unit, must be equally safe.
- The responsible body must design the system to ensure it is safe.
- Huber is not responsible for the safety of your system. The responsible body is responsible for the safety of the system.
- Although the temperature control unit provided by Huber meets all the applicable safety standards, integration into a system may give rise to hazards that are characteristic of the other system's design and beyond the control of Huber.
- It is the responsibility of the system integrator to ensure that the overall system, into which this temperature control unit is integrated, is safe.
- The **>Mains isolator<** [36] (if present) can be locked in the off position to facilitate safe system installation and maintenance of the temperature control unit. It is the responsibility of the responsible body to develop any lock-out/tag-out procedure for the energy source in accordance with local regulations (e.g. CFR 1910.147 for the US).

1.4.1.1 Proper disposal of resources and consumables

Do comply with all national disposal regulations applicable for you. Contact your local waste management company for any questions concerning disposal.

Overview	Material / Aids	Disposal / Cleaning
	Packaging material	Keep the packaging material for future use (e.g. transport).
	Thermal fluid	Please refer to the safety data sheet of the thermal fluid used for information on its proper disposal. Use the original thermal fluid container when disposing it.
	Filling accessories, e.g. beaker	Clean the filling accessories for reuse. Make sure that the materials and cleaning agents used are properly disposed of.
	Aids such as towels, cleaning cloths	Tools used to take up spilled thermal fluid must be disposed of in the same fashion as the thermal fluid itself. Tools used for cleaning must be disposed of depending on the cleaning agent used.
	Cleaning agents such as stainless steel cleaning agents, sensitive-fabrics detergents	Please refer to the safety data sheet of the cleaning agent used for information on its proper disposal. Use the original containers when disposing of large quantities of cleaning agents.
	Consumables such as air filter mats, temperature control hoses	Please refer to the safety data sheet of the consumables used for information on their proper disposal.

1.4.1.2 Temperature control unit with natural refrigerants (NR)



Over 8 g refrigerant per m³ room air
DEATH OR SERIOUS INJURY DUE TO EXPLOSION

- Observe the rating plate (amount of natural refrigerant contained) and the room size (maximum room concentration of natural refrigerant in case of leakage) when installing the temperature control unit.
- Over 8 g refrigerant per m³ room air: A gas warning sensor must be fitted and functioning.
- The gas warning sensor must be calibrated and maintained at regular intervals (between 6 and 12 months).
- The temperature control unit is not approved for operation **in an ATEX zone.**

Huber products with natural refrigerants work with numerous proven, safe and highly-sustainable technologies. The relevant standards and regulations for temperature control units with natural refrigerants contain a number of stipulations, the importance of complying with which is set out below. Please additionally: → Page 13, section »**Proper operation**«.

Huber temperature control units are constructed to be permanently sealed and are carefully checked for leak tightness. Temperature control units with more than 150 g natural refrigerant are equipped with an additional gas warning sensor. To find out whether your temperature control unit is equipped with a gas warning sensor, refer to the data sheet. → From page 71, section »**Annex**«.

For the filling capacity of the temperature control unit, refer to the data sheet. → From page 71, section »**Annex**«. Or to the rating plate on the back of the temperature control unit. Please also consider: → Page 23, section »**Ambient conditions**« and → Page 25, section »**Installation conditions**«.

Classifying the application field

Class of application field	Application field	Example of the installation location	Max. quantity of refrigerant	AND	Max. permissible quantity above ground level (GL)
A	General	Publicly accessible area in a public building	8 g/m ³ ambient air		1.5 kg
B	Monitored	Laboratories			2.5 kg
C	Access only for authorized persons	Production equipment			10.0 kg
Temperature control units with more than 1 kg refrigerant must not be installed below ground level (GL).					

Temperature control units with up to 150 g natural refrigerant

- The temperature control unit has been constructed to the requirements of EU and EFTA countries.
- Use the table as guidance for classifying the application field. Respect the max. refrigerant quantity stated therein.

Temperature control units WITH pre-installed gas warning sensor and > 150 g natural refrigerant

- The temperature control unit has been constructed to the requirements of EU and EFTA countries.
- Use the table as guidance for classifying the application field. Respect the max. refrigerant quantity or the permissible highest quantity above ground level (GL) stated therein.
- **Ventilation with optional supply and exhaust air connection:** Use the temperature control unit's supply and exhaust air connection to connect it to the building's exhaust system. For the exact position please refer to the wiring diagram. → From page 71, section »**Annex**«. First, remove the cover to the air inlet connection; an air filter mat is installed behind it. This air filter mat must be checked / replaced at regular intervals so that the air flowing into the temperature control unit is not reduced. → Page 61, section »**Function check and visual inspection**«. Connect the building's exhaust system with the temperature control unit's exhaust air port. The cover of the supply air port **must not be removed if the exhaust system provided in a building is not used.**
- **The mounting plate for mounting a gas warning sensor is located inside the temperature control unit in the vicinity of the >Cable entry gas warning sensor< [100].**
- For the position of the >Cable entry gas warning sensor< [100] please refer to the wiring diagram. → From page 71, section »**Annex**«.
- Additional information on the pre-installed gas detection sensor:
 - The built-in gas detection sensor enables a **safety shutdown at 20% of the lower explosive limit via a power disconnect relay that is to be installed by the operator.** The temperature control unit is thus switched off early and safely in case of fault.
 - A **24 V DC external power supply** must be available for the pre-installed gas warning sensor. The alarm output of the gas warning sensor uses a 4 - 20 mA signal. Please refer to the data sheet of the gas warning sensor for further technical information. A **separate processing unit is available as an accessory** for the control of the power disconnect relay. The processing unit provides a potential-free switching contact and simultaneously provides the power supply and analysis of the gas warning sensor. Both variants require the operator to provide the necessary dimensioning and installation. Please refer to the data sheet of the gas warning sensor for the technical information necessary for the installation. The

alarm of the gas detection system can be connected to the operator's alarm control unit. The operator is responsible for this and for the other measures.

- The operator is responsible for the **calibration of the gas detection sensor** prior to initial operation and the observance of calibration and maintenance intervals according to the operating manual. We recommend to set calibration and maintenance intervals between 6 and 12 months if no information is provided. For increased safety requirements, shorter intervals can be specified. On request we will recommend a specialist company to carry out the calibration and maintenance.

Temperature control units WITHOUT pre-installed gas warning sensor and > 150 g natural refrigerant



WARNING

Over 8 g refrigerant per m³ room air

DEATH OR SERIOUS INJURY DUE TO EXPLOSION

- Observe the rating plate (amount of natural refrigerant contained) and the room size (maximum room concentration of natural refrigerant in case of leakage) when installing the temperature control unit.
- Over 8 g refrigerant per m³ room air: A gas warning sensor must be fitted and functioning.
- The gas warning sensor must be calibrated and maintained at regular intervals (between 6 and 12 months).
- The temperature control unit is not approved for operation **in an ATEX zone**.

- The temperature control unit has been constructed to the requirements of EU and EFTA countries.
- Use the table as guidance for classifying the application field. Respect the max. refrigerant quantity or the permissible highest quantity above ground level (GL) stated therein.
- **Ventilation with optional supply and exhaust air connection:** Use the temperature control unit's supply and exhaust air connection to connect it to the building's exhaust system. For the exact position please refer to the wiring diagram. → From page 71, section »Annex«. First, remove the cover to the air inlet connection; an air filter mat is installed behind it. This air filter mat must be checked / replaced at regular intervals so that the air flowing into the temperature control unit is not reduced. → Page 61, section »Function check and visual inspection«. Connect the building's exhaust system with the temperature control unit's exhaust air port. The cover of the supply air port **mustnot be removed** if the exhaust system provided in a building is not used.
- **NO gas warning sensor is installed in this temperature control unit!** Make sure that the installation site of the temperature control unit is sufficiently protected in the event of malfunction. This includes:
 - Installation of a building's gas warning sensor (room monitoring).
 - Permanent ventilation of the temperature control unit and/or the installation site.
 - All-pole disconnection in the event of malfunction of the temperature control unit.

1.4.1.3 Temperature control units with fluorinated greenhouse gases/refrigerants

F gases regulation (EC) No. 517/2014 of April 16, 2014, on fluorinated greenhouse gases, and repealing Regulation (EC) No. 842/2006.

These regulations deal with all systems that contain fluorinated refrigerants. The substances dealt with in Directive (EC) No. 1005/2009 of the European Parliament and of the Council of 16 September 2009 that deplete the ozone layer are excluded (CFC/HCFC).

The directive regulates the reduction of the emission, utilization, recovery, and destruction of certain fluorinated greenhouse gases. It also regulates the identification and disposal of products and devices that contain these gases. Since July 4, 2007, responsible bodies must check their stationary refrigeration systems for leaks at regular intervals, and have any leaks eliminated immediately.

Directive (EC) No. 303/2008 contains stipulations on the training and certification of companies and personnel that are permitted to execute the specified activities.

Obligations of the responsible bodies:

- Directive (EC) No. 842/2006 already imposed a number of obligations upon responsible bodies regarding certain fluorinated greenhouse gases. The new Ordinance on Fluorinated Greenhouse Gases upholds these to a large extent. Some duties are added while others are designed differently by this new ordinance. Please refer to the text of this ordinance for a complete overview of the individual responsibilities of responsible bodies.
- General obligation to reduce emissions.

- Only certified companies may maintain, repair or decommission refrigeration systems. The responsible bodies must verify that these companies are certified.
- Regular leak tests of stationary refrigeration systems by certified personnel (such as Huber service engineers). The required test interval is based on the refrigerant filling capacity and the type of refrigerant, converted to CO₂ equivalent.
- Responsibility of responsible bodies operating a plant to recover F-gases by certified personnel.
- Obligatory documentation requirement in the refrigeration system's operation manual, specifying type and volume of refrigerant used or recovered. The responsible body must keep the records for at least 5 years after their creation and present it to the responsible authority upon request.
- Temperature control units with natural refrigerants (NR) are exempt from this Directive.
- Please refer to the data sheet or rating plate of your temperature control unit for the quantity and type of refrigerant.
- Additional information about the definition of the inspection interval can be found on our website.

1.4.2 Requirements for operators

Work on the temperature control unit is reserved for appropriately qualified specialists, who have been assigned and trained by the responsible body to do so. Operators must be at least 18 years old. Under 18-year olds may operate the temperature control unit only under the supervision of a qualified specialist. The operator is responsible vis-a-vis third-parties in the work area.

1.4.3 Obligations of the operators

Carefully read the operation manual before operating the temperature control unit. Please observe the safety instructions. When operating the temperature control unit, wear appropriate personal protective equipment (e.g. safety goggles, protective gloves, non-slip shoes).

1.5 General information

1.5.1 Description of workstation

The workstation is located at the control panel in front of the temperature control unit. The workstation is determined by the customer's connected peripheries. Accordingly, it must be designed safe by the responsible body. The workstation design also depends on the applicable requirements of the German occupational health and safety regulations [BetrSichV] and the risk analysis for the workstation.

1.5.2 Safety devices to DIN 12876

The rating of your temperature control unit is stated on the data sheet in the appendix.

Rating of laboratory thermostats and laboratory baths	Classification	Temperature control medium	Technical requirements	Identification ^{d)}
	I	Non-combustible ^{a)}	Overheat protection ^{c)}	NFL
	II	Combustible ^{b)}	Adjustable overheat protection	FL
	III	Combustible ^{b)}	Adjustable overtemperature protection and additional low-level protection	FL
^{a)} Usually water; other fluids only if non-combustible even within the temperature range of an individual fault. ^{b)} The temperature control media must have a fire point of ≥ 65 °C. ^{c)} The overheat protection can, for instance, be realized using a suitable fill level sensor or a suitable temperature limiter. ^{d)} Optional at the choice of the manufacturer.				

Overview of the temperature thresholds

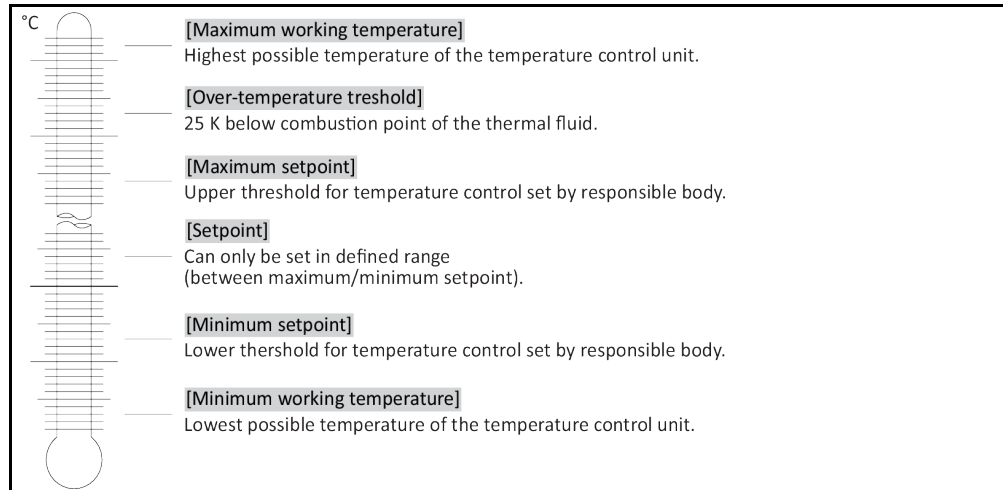

Combined electronic low level and overtemperature protection

Some temperature control units (device dependent) feature an electronic overtemperature and low-level protection. Instead of a mechanical float device, temperature sensors are employed on the surface of the heating coils. These sensors monitor overtemperature at this potential ignition source, thus ensuring that the controller regulates the heating coil temperatures below the critical temperature (fire point of the thermal fluid). This does not apply to chillers where the level is capacitively determined). An appropriate message is output on the >Touchscreen< [88]. Please note the figure "Pilot ONE". → Page 6.

There is no longer a need for mechanical tools to set the trigger values of the overtemperature protection. It is replaced by a software engineering tool. The threshold value for the overtemperature protection can be set only if a code, randomly generated by "Pilot ONE", is entered correctly. As with the mechanical tool, accidental settings are thus prevented.

1.5.3 Further protective devices

INFORMATION

Emergency strategy – interrupt the power grid connection!

To determine the type of switch or switch combination your temperature control unit is equipped with, please refer to the wiring diagram. → From page 71, section »Annex«.

Temperature control units with >Mains isolator< [36] (red/yellow or gray): Turn the >Mains isolator< [36] to the "0" position.

Temperature control units with >Mains isolator< [36] (red/yellow) and additional >Appliance switch< [37] (gray): Turn the >Mains isolator< [36] to the "0" position. Then turn the >Appliance switch< [37] to the "0" position!

Temperature control units with >Mains isolator< [36] (gray) and >Emergency stop switch< [70] (red/yellow): Press the >Emergency stop switch< [70]. Then turn the >Main switch< [36] to the "0" position!

Temperature control units with >Mains switch< [37]: Power supply via socket: Disconnect the temperature control unit from the power supply. Then turn the >Mains isolator< [37] to the "0" position! Power supply via hard wiring: Disconnect the power grid supply by means of the building's circuit breaker. Then turn the >Mains isolator< [37] to the "0" position!

Temperature control units without a switch or inside a protective housing: Connection via socket: Disconnect the temperature control unit from the power supply. Connection via hard wiring: Disconnect the power grid supply by means of the building's circuit breaker!

1.5.3.1 Power interruption

Following a power outage (or when switching on the temperature control unit), this function can be used to determine how the temperature control unit is supposed to respond. This response can be determined via "Pilot ONE".

OFF/Standby (Default setting)

After turning the temperature control unit on, thermoregulation is started only after manual input.

ON / Temperature control active

After turning on the temperature control unit, thermoregulation is always started. An INFO appears for a few seconds. This makes it possible to suppress the automatic start.

Power Failure Auto

If temperature control is active during a power outage, the process will automatically continue after the power outage.

1.5.3.2 Alarm functions

An alarm is a system state that signals unfavorable process conditions. The temperature control unit can be programmed so that the plant operator is warned when defined limit values are exceeded.

The response of the temperature control unit to an alarm can be determined. Possible responses are: Switch off temperature control or control temperature to a safe setpoint (2nd setpoint).

1.5.3.3 Warning messages

Warning messages contain a message about the irregularity of the temperature control unit. These messages have no further consequences. The plant operator evaluates the relevance of the message and takes action where necessary.

2 Commissioning

2.1 In-plant transport

WARNING

Temperature control unit is not transported / moved according to the specifications in this operation manual

DEATH OR SERIOUS INJURY DUE TO CRUSHING

- Always transport / move the temperature control unit according to the specifications in this operation manual.
- Wear personal protective equipment during transport.
- Always work with the specified number of persons when moving the temperature control unit on casters (if any).
- If the temperature control unit is equipped with casters and parking brakes: 2 parking brakes are always freely accessible when moving the temperature control unit. Activate the **2 parking brakes** in an emergency! If only **one** parking brake is activated on the casters in an emergency: The temperature control unit is not stopped but rotates around the axis of the caster with the activated parking brake!

NOTE

Temperature control unit transported in a horizontal position

DAMAGE TO THE COMPRESSOR

- Only transport the temperature control unit in an upright position.

NOTE

Filled temperature control unit is transported

MATERIAL DAMAGE DUE TO OVERFLOWING THERMAL FLUID

- Only transport an emptied temperature control unit.

- If available, use the lugs on the top side of the temperature control unit for transportation.
- Use an industrial truck for transport.
- The casters (if present) on the temperature control unit are not suitable for transport. The casters are symmetrically loaded with 25% of the total mass of the temperature control unit.
- Remove the packing material (e.g. the palette) only at the place of installation.
- Protect the temperature control unit from transport damage.
- Do not transport the temperature control unit alone and without aids.
- Check the load bearing capacity of the transportation route and the place of installation.
- The parking brakes at the casters (if any) must be activated and/or the leveling feet (if any) must be unscrewed/activated before the temperature control unit is put into operation. → Page 28, section »Unscrewing/activating the leveling feet (if any)«.

2.1.1 Lifting and transporting the temperature control unit

2.1.1.1 Temperature control unit with lifting eyes

NOTE

The temperature control unit is raised at the lifting eyes without load handling attachments

DAMAGE TO THE TEMPERATURE CONTROL UNIT

- Always use load handling attachments when lifting and transporting the temperature control unit.
- The lifting eyes are only designed for a load **without** inclination (0°).
- The load handling attachment used must be adequately dimensioned. Take the dimensions and weight of the temperature control unit into account.

Example: lifting eyes
(round, angular, and
recessed (left to right))

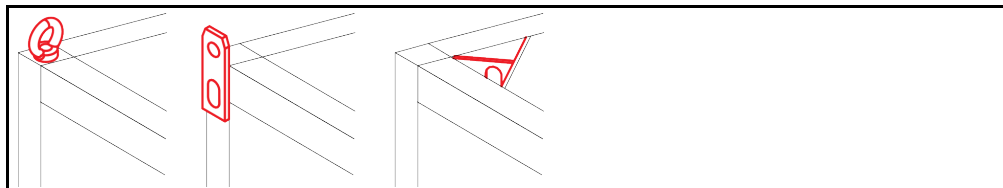

- Do not lift and transport the temperature control unit at the lifting eyes alone and without aids.
- Lift and transport the temperature control unit at the lifting eyes only with a crane or an industrial truck.

- The crane or industrial truck must have a lifting force equal to or greater than the weight of the temperature control unit. See the data sheet for the weight of the temperature control unit. → From page 71, section »Annex«.
- If the leveling feet have been removed for shipping: Only lower the temperature control unit when all leveling feet have been installed. → Page 22, section »Mounting/removing leveling feet«.

2.1.1.2 Temperature control unit without lifting eyes

Example: Supporting points for forklift arms for free-standing models from a certain overall size. For the exact position please refer to the wiring diagram in the annex.

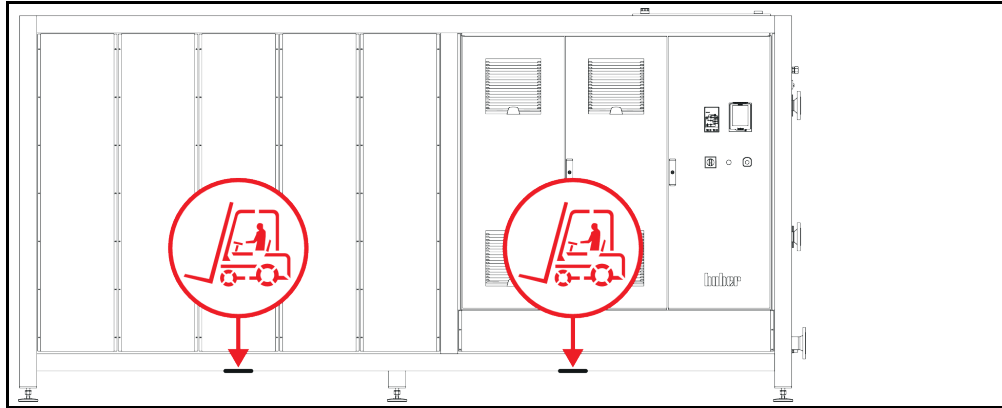

- Do not lift and transport the temperature control unit alone and without aids.
- Lift and transport the temperature control unit only with an industrial truck.
- The industrial truck must have a lifting force equal to or greater than the weight of the temperature control unit. See the data sheet for the weight of the temperature control unit. → From page 71, section »Annex«.
- If the leveling feet have been removed for shipping: Only lower the temperature control unit when all leveling feet have been installed. → Page 22, section »Mounting/removing leveling feet«.

2.1.2 Mounting/removing leveling feet

Only valid if the leveling feet have been removed for shipping.



WARNING

**The temperature control unit is not secured against slipping and/or lowering
DEATH OR SERIOUS INJURY DUE TO CRUSHING**

- Secure the temperature control unit against slipping and/or lowering before the leveling feet are mounted.
- Do not stand or lie under the temperature control unit for mounting.

Example: mounting the leveling feet

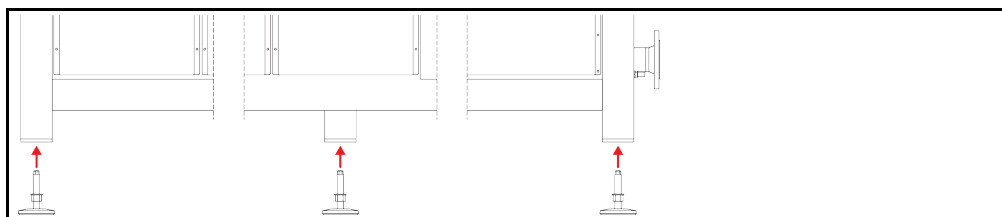

INFORMATION

The leveling feet were removed for shipping the temperature control unit. Before placing / positioning the temperature control unit all leveling feet must be mounted. If the temperature control unit is re-shipped: Remove all leveling feet before packaging.

- The leveling feet can only be mounted while the temperature control unit is lifted.
- Secure the temperature control unit against slipping and/or lowering.
- Do not stand or lie under the temperature control unit while mounting the leveling feet.
- Do not lower the temperature control unit until all leveling feet have been mounted.

2.1.3 Positioning the temperature control unit

2.1.3.1 Temperature control unit with casters

- Do **not** use the casters for the transportation to the place of installation. → Page 21, section »**Lifting and transporting the temperature control unit**«.
- Use the casters only for positioning at the place of installation.
- Only ever move the temperature control unit on the casters if the surface is level, without gradient, non-slip and stable.
- Do not move the temperature control unit alone.
- **At least 2 persons** are required to move the temperature control unit on casters. **At least 5 persons** are required to move the temperature control unit on the casters if the total weight of the temperature control unit is **over 1.5 tons**.
- The parking brakes must be activated at the casters and/or the feet (if present) must be unscrewed/activated before the temperature control unit is put into operation. → Page 28, section »**Unscrewing/activating the leveling feet (if any)**«.

2.1.3.2 Temperature control unit without casters

- An industrial truck must be used for positioning the temperature control unit.
- Do not move the temperature control unit alone.
- **At least 2 persons** are required to move the temperature control unit.
- The industrial truck must have a lifting force equal to or greater than the weight of the temperature control unit. See the data sheet for the weight of the temperature control unit. → From page 71, section »**Annex**«.
- The leveling feet (if present) must be unscrewed/activated before the temperature control unit is put into operation. → Page 28, section »**Unscrewing/activating the leveling feet (if any)**«.

2.2 Unpacking



WARNING

Starting up a damaged temperature control unit

DANGER TO LIFE FROM ELECTRIC SHOCK

- Do not operate a damaged temperature control unit.
- Please contact Customer Support. → Page 70, section »**Contact data**«.

PROCEDURE

- Check for damage to the packaging. Damage can indicate material damage to the temperature control unit.
- Check for any transport damage when unpacking the temperature control unit.
- Always contact your forwarding agent regarding the settlement of claims.
- Observe the proper disposal of packaging material. → Page 15, section »**Proper disposal of resources and consumables**«.

2.3 Ambient conditions



CAUTION

Unsuitable ambient conditions / unsuitable installation

SERIOUS INJURY DUE TO CRUSHING

- Comply with all requirements! → Page 23, section »**Ambient conditions**« and → Page 25, section »**Installation conditions**«.

INFORMATION

Make sure there is adequate fresh air available at the site for the circulation pump and the compressors. The warm exhaust air must be able to escape upwards unhindered.

Free-standing models

For the connection data, see the data sheet. → From page 71, section »**Annex**«.

Use of the temperature control unit is permitted only under normal ambient conditions in accordance with the currently valid DIN EN 61010-1.

- Use only indoors. The illuminance must be at least 300 lx.
- Installation altitude up to 2,000 meters above sea level.
- Maintain wall and ceiling clearance for adequate air exchange (dissipation of waste heat, supply of fresh air for the temperature control unit and work area). Ensure adequate floor clearance for air-cooled temperature control units. Do not operate this temperature control unit from within the box or with an inadequately dimensioned bath. This inhibits the air exchange.
- Ambient temperature values are provided on the technical data sheet; to ensure trouble-free operation, compliance with the ambient conditions is mandatory.
- Relative humidity max 80% to 32 °C and 40 °C decreasing linearly to 50%.
- Short distance to supply connections.
- The temperature control unit must not be installed so as to hinder or even prevent access to the disconnecting device (to the power supply).
- For the magnitude of the mains voltage fluctuations, refer to the datasheet. → From page 71, section »Annex«.
- Transient surges, as would normally occur in the power supply system.
- Installation Class 3
- Applicable degree of soiling: 2.
- Surge category II.

Wall clearances

Side	Distance in cm	
	Air cooling	Water cooling
[A1] Top	Air outlet on top of unit: free standing	–
[B] Left	min. 20	min. 10
[C] Right	min. 20	min. 10
[D] Front	min. 20	min. 10
[E] Rear	min. 20	min. 20
Side	Distance in cm (for operation in a tub)	
	Air cooling	Water cooling
[A1] Top	Air outlet on top of unit: free standing	–
[B] Left	min. 20	min. 20
[C] Right	min. 20	min. 20
[D] Front	min. 20	min. 20
[E] Rear	min. 20	min. 20

2.3.1 EMC-specific notes

INFORMATION

Connecting cables in general

Prerequisites for a failure-free operation of the temperature control units incl. their connections with external applications: Installation and wiring must be carried out professionally. Related topics: "Electrical safety" and "EMC-compliant wiring".

Cable lengths

For flexible/fixed cable routing of more than 3 meters, the following must amongst other things be observed:

- Equipotential bonding, grounding (see also technical data sheet "Electromagnetic compatibility EMC")
- Compliance with "external" and/or "internal" lightning/overvoltage protection.
- Design protection measures, professional cable selection (UV resistance, steel pipe protection, etc.)

Attention:

The operating company is responsible for compliance with national/international directives and laws. This also includes the testing of the installation/wiring required by law or standards.

This device is suitable for operation in "industrial electromagnetic environments". It meets the "immunity requirements" of the currently applicable **EN61326-1**, which are required for this environment.

It also meets the "interference emission requirements" for this environment. It is a **Group 1** and **Class A** device according to the currently applicable **EN55011**.

Group 1 specifies that high frequency (HF) is only used for the function of the device. **Class A** defines the interference emission limits to be observed.

2.4 Installation conditions

WARNING

Temperature control unit is connected to the power supply line

DEATH FROM ELECTRICAL SHOCK BY DAMAGE TO THE POWER CABLE.

- Do not put temperature control unit on power cable.

CAUTION

Operating the temperature control unit fitted with casters without brakes activated

CRUSHING OF LIMBS

- Activate brakes on the casters.

- Allow the temperature control unit to acclimate for about 2 hours when changing from a cold to a warm environment (or vice versa). Do not turn on the temperature control unit before!
- Install upright, stable and tilt-resistant.
- Use a non-combustible, sealed foundation.
- Keep the environment clean: Prevent slip and trip hazards.
- Wheels, if installed, must be locked after installation!
- Spilled/leaked thermal fluid must be removed immediately. Observe the proper disposal of thermal fluid and aids. → Page 15, section »Proper disposal of resources and consumables«.
- Observe the floor load bearing capacity for large units.
- Observe the ambient conditions.

2.5 Recommended cooling water hoses

CAUTION

Use of unsuitable/defective hoses and/or hose connections

INJURIES

- Reinforced hoses must be used to satisfy tougher safety requirements.
- Shut off the cooling water supply to the temperature control unit even for shorter downtimes (e.g. overnight).

CAUTION

Hot or cold thermal fluid and surfaces

BURNS TO LIMBS

- Avoid direct contact with the thermal fluids or the surfaces.
- Wear your personnel protective equipment (e.g. temperature-resistant safety gloves, safety goggles, safety footwear).

- We **exclusively** recommend reinforced hoses for connecting to the cooling water supply. Cooling water hoses can be found in the Huber catalog under Accessories.

2.6 Wrench sizes and torques

Note the wrench sizes that result for the pump connection on the temperature control unit. The following table lists the pump connections and the resulting wrench sizes, and torque values. A leak test must always be performed, and the connections tightened if necessary. The values of the maximum torque (see table) must **not** be exceeded.

Overview
wrench sizes and
torques

Connection	Sleeve nut wrench size	Connector wrench size	Recommended torques in Nm	Maximum torques in Nm
M16x1	19	17	20	24
M24x1.5	27	27	47	56
M30x1.5	36	32	79	93
	36	36	79	93
M38x1.5	46	46	130	153
G-thread (flat-sealing)	Adapt the torque to the material of the flat seal used. First hand-tighten the temperature control hose. When using adapters, do not overtighten the G-thread on the pump connection when connecting a temperature control hose. When connecting a temperature control hose to the adapter piece, secure the G thread against overwinding.			

2.7 Temperature control units with water cooling

CAUTION

Use of unsuitable/defective hoses and/or hose connections

INJURIES

- Reinforced hoses must be used to satisfy tougher safety requirements.
- Shut off the cooling water supply to the temperature control unit even for shorter downtimes (e.g. overnight).

NOTE

No protection against corrosion

DAMAGE TO THE TEMPERATURE CONTROL UNIT

- The addition of anti-corrosion agents is mandatory if salts (chlorides, bromide) have been added to the water circuit.
- Ensure that the materials used in the cooling water circuit are resistant with respect to the cooling water. For information on materials used see the data sheet. → From page 71, section »Annex«.
- Take suitable measures to maintain the warranty conditions.
- For information about water quality, see www.huber-online.com.

NOTE

Usage of un-filtered river/sea or ocean water as cooling water

DAMAGE TO THE TEMPERATURE CONTROL UNIT

- Un-filtered river or sea water is not suitable for use as cooling water due to its contaminants.
- Use drinking water or filtered river or sea water for cooling.
- Sea water must not be used for water cooling.
- For information about water quality, see www.huber-online.com.

Connection diagram

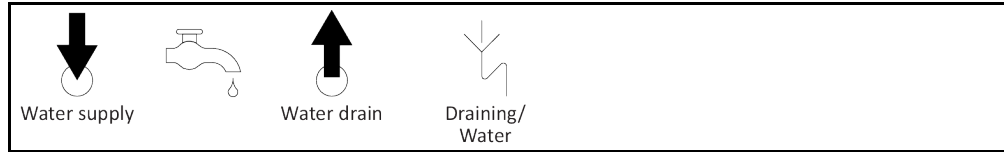

Installing a suction strainer (table-top models only)

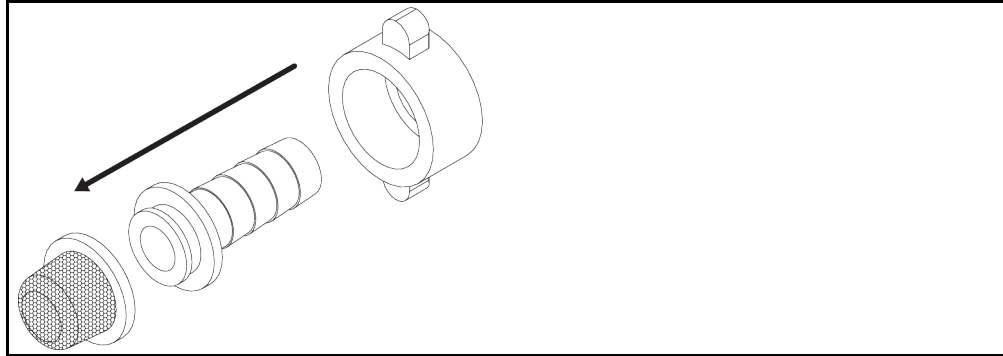

Preparing the temperature control unit with water cooling:

INFORMATION

To minimize cooling water consumption, Huber temperature control units with water cooling are equipped with a cooling water regulator. It limits the flow of cooling water to the amount required by the current load situation of the temperature control unit. If only a low cooling capacity is requested, only a small amount of cooling water is consumed. It cannot be ruled out that cooling water flows when the machine is switched off. Shut off the cooling water supply to the temperature control unit even for shorter downtimes (e.g. overnight).

Use of drinking water for water cooling purposes: A backflow from the cooling water line into the drinking water supply must be prevented on the building side. The responsible body must check and apply the national regulations applicable for it accordingly.

In the event of outdoor installation, the responsible body must ensure that the cooling water supply and return lines are laid frost-protected. The cooling water temperature must not fall below 3 °C. At ambient temperatures below 3 °C, the cooling water supply must be heated.

The minimum pressure differential in the cooling water circuit and the recommended cooling water inlet temperature can be found on the data sheet. → From page 71, section »Annex«.

Observe the wiring diagram. → From page 71, section »Annex«.

PROCEDURE

- Close (if fitted) the >Cooling water drain< [15].
- Connect the >Cooling water outlet< [14] to the water return flow. A seal must be used.
- Insert the suction strainer (dirt trap) into the >Cooling water return< [13].
- Connect the >Cooling water inlet< [13] to the water supply.

NOTE

Leaking cooling water connections

DAMAGE BY FLOODING OF ROOMS

- Slowly open the building-side isolating valves of the cooling water supply and return line.
 - If water leaks from the cooling water connections: Shut off the cooling water supply and return line immediately.
 - Provide leakproof cooling water connections.
-
- Open the shut-off valves in the water line on the temperature control unit (if present) and on the building side.
 - Check the connections for leaks.

2.8 Temperature control unit with batch

2.8.1 Operation as bath thermostat

Note the volume displacement caused by a sample. Place your sample into the empty bath. Only then fill in a sufficient amount of temperature control medium. Also note that the level of the temperature control medium drops when you remove the sample. This may cause a safety shutdown (low level protection) during an enabled thermoregulation. Therefore, switch off the temperature control unit beforehand.

2.9 Preparations for operation

2.9.1 Unscrewing/activating the leveling feet (if any)



WARNING

The leveling feet are not unscrewed/activated before switching on the temperature control unit DEATH OR SERIOUS INJURY DUE TO CRUSHING

- The parking brakes must be activated at the casters (if any) and/or the leveling feet must be unscrewed/activated before the temperature control unit is put into operation.
- The temperature control unit may move if the parking brakes of the casters (if any) are not activated and/or the leveling feet are not unscrewed/activated.

Always unscrew/activate the leveling feet before switching on the temperature control unit. Uneven floors can be compensated by adjusting these leveling feet.

PROCEDURE

- Verify that the parking brakes of the casters (if any) have been activated.
- Unscrew the leveling feet.
- Compensate uneven floors by adjusting these leveling feet, if necessary. Use a spirit level to horizontally align the temperature control unit.
- Tighten the lock screws on the leveling feet after aligning the temperature control unit. This prevents the leveling feet from changing their height during operation.

2.9.2 Opening/closing valves

Opening and closing valves

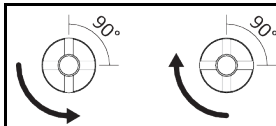

INFORMATION

Opening valves:

Open valves by turning them counterclockwise (turn 90° left as far as it will go).

Close valves:

close valves by turning them clockwise (turn 90° right as far as it will go).

PROCEDURE

- Check that all valves are closed.
- Close all valves by turning them clockwise (turn 90° right as far as it will go).

2.9.3 Connecting the functional earth

PROCEDURE

- If required, connect the temperature control unit's **>Functional ground terminal<** [87] to the building's grounding point. Use a ground strap for this purpose. For the exact position and thread size please refer to the wiring diagram. → From page 71, section »Annex«.

2.10 Connecting to the power supply

INFORMATION

Based on local circumstances, it may be that you need to use an alternative power cable instead of the supplied original power cable. Do not use a power cable that is longer than **3 m** to be able to disconnect the temperature control unit at any time from the mains. Have the mains cable only replaced by a qualified electrician.

2.10.1 Connection using socket with protective earth (PE)

DANGER

Connecting to a power socket without protective earth (PE)

MORTAL DANGER FROM ELECTRIC SHOCK

- Always connect the temperature control unit to safety sockets (PE).

DANGER

Damaged power cable/power cable connection

MORTAL DANGER FROM ELECTRIC SHOCK

- Do not start up the temperature control unit.
- Isolate the temperature control unit from the power supply.
- Have the power supply cable/power supply connection replaced and inspected by an electrician.
- Do not use a power cable that is longer than **3 m**.

NOTE

Incorrect power supply connection

DAMAGE TO THE TEMPERATURE CONTROL UNIT

- Your building's existing power supply voltage and frequency must match the data provided on the rating plate of the temperature control unit.

INFORMATION

In case of uncertainties about an existing protective earth (PE), have the connection inspected by an electrician.

2.10.2 Connection via hard wiring

DANGER

Connection/adjustment to the power supply not carried out by an electrician

MORTAL DANGER FROM ELECTRIC SHOCK

- Have the connection/adjustment to the power supply carried out by an electrician.

DANGER

Damaged power cable/power cable connection

MORTAL DANGER FROM ELECTRIC SHOCK

- Do not start up the temperature control unit.
- Isolate the temperature control unit from the power supply.
- Have the power supply cable/power supply connection replaced and inspected by an electrician.
- Do not use a power cable that is longer than **3 m**.

NOTE

Incorrect power supply connection

DAMAGE TO THE TEMPERATURE CONTROL UNIT

- Your building's existing power supply voltage and frequency must match the data provided on the rating plate of the temperature control unit.

3 Function description

3.1 Function description of the temperature control unit

3.1.1 General functions

The **CC heating circulators** are **temperature control units** ideally suited for the thermoregulation of baths. This **controller generation** is characterized by the fact that there is only a **single hardware**. For a license fee you will receive an **activation key**, which allows you to quickly expand the functionality of e.g. a simple temperature control unit (basic version) to its **maximum functionality** (professional version) at any time.

Thanks to the **low internal volume** and the **efficient refrigeration/heat technology** (in case of temperature control units with compressor cooling, you will achieve relatively **short cooling/heating rates**.

3.1.2 Other functions

The **speed-controlled pump**, integrated into many table-top models and some free-standing models, enables the **speed** and thus the **pressure** of the thermal fluid to be controlled and hence optimally matched to the specified application.

The **self-optimizing cascade control** delivers **optimal controller results** for regulating levels up and down, both with **setpoint changes** and also with **exothermic reactions**. Temperature control can be either a-periodic or with a slight overshoot (faster).

Your temperature control unit can be easily integrated into many laboratory automation systems. This is provided for by the existing **standard interfaces Ethernet, USB device and USB host at the "Pilot ONE"**. The optional Com.G@te allows you to expand your temperature control unit by **digital interfaces (RS232 and RS485), an analogue current loop interface (0/4 - 20 mA or 0 - 10 V) and various digital control options (In/Out)**.

The **removable control panel ("Pilot ONE")** can also be used as a **remote control**. Please contact your dealer or Huber Sales Department if you need an extension cable. → Page 70, section »**Contact data**«.

The temperature control unit can be retrofitted with an **integrated temperature ramp function** and an **internal temperature programmer** via an "E-grade" upgrade. The "E-grade" upgrade "**Exclusiv**" enables you to set and call 3 temperature control programs with 5 program steps each by using the integrated programmer. The "E-grade" upgrade "**Professional**" enables you to set and call 10 temperature control programs with a total of 100 program steps by using the integrated programmer.

The temperature control unit has **overtemperature protection to DIN EN 61010-2-010, independent** of the control circuit itself (valid for temperature control units with heater).

3.2 Information on the thermal fluids



CAUTION

Non-compliance with the safety data sheet for the thermal fluid to be used INJURIES

- Risk of injury to the eyes, skin, respiratory tract.
- The safety data sheet for the thermal fluid to be used must be read prior to using it and its content must be respected.
- Observe the local regulations/work instructions.
- Wear your personal protective equipment (e.g. temperature-resistant safety gloves, safety goggles, safety footwear).
- Danger of slipping because floor and work area are contaminated. Clean the workplace; observe the proper disposal of thermal fluid and aids. → Page 15, section »**Proper disposal of resources and consumables**«.

NOTE

Non-compliance with the compatibility between the thermal fluid and your temperature control unit

MATERIAL DAMAGE

- Observe the classification of your temperature control unit according to DIN 12876.
- Ensure the following materials are resistant with respect to the thermal fluid: Stainless steel 1.4301/ 1.4401 (V2A), copper, nickel, FKM, red bronze/brass, silver solder and plastic.
- The maximum viscosity of the thermal fluid must not exceed 50 mm²/s at the lowest working temperature!
- The maximum density of the thermal fluid may not exceed 1 kg/dm³!

NOTE

Mixing different thermofluids in a thermal fluid circuit

PROPERTY DAMAGE

- Do **not** mix different types of thermofluid (such as mineral oil, silicone oil, synthetic oil, water, etc.) in a thermofluid circuit.
- The thermal fluid circuit **must** be rinsed when changing from one type of thermal fluid to another. No residues of the previous type of thermal fluid may remain in the thermal fluid circuit.

Thermal fluid: Water

Designation	Specification
Calcium carbonate per liter	≤ 1.5 mmol/l; corresponds to a water hardness of: ≤ 8.4 °dH (soft)
pH value	between 6.0 and 8.5
Ultrapure water, distillates	Add 0.1 g of sodium carbonate (Na ₂ CO ₃) per liter
Non-approved water	Distilled, deionized, demineralized, chloric, ferruginous, ammoniacal, contaminated or untreated river water or sea water
Thermal fluid: Water without ethylene glycol	
Operation without freeze protection	≥ +5 °C
Operation with freeze protection	< +5 °C
Thermal fluid: Water-ethylene glycol mixture	
Use	< 0 °C
Thermal fluid composition	The mixture's temperature must be 10 K below the permissible min. temperature. For the permissible temperature range, refer to the datasheet. → From page 71, section »Annex«.

INFORMATION

For thermal fluids we recommend the media listed in the Huber catalog. The name of a thermal fluid is derived from its working temperature range and its viscosity at 25 °C.

3.3 To be noted when planning the test

INFORMATION

Observe the intended operation. → Page 13, section »Proper operation«.

The focus is on your application. Bear in mind that system performance is influenced by heat transfer, temperature, thermal fluid viscosity, volume flow, and flow speed.

- Make sure that the electrical connection is adequately dimensioned.
- The installation location of the temperature control unit should be selected so as to ensure adequate fresh air, even with water-cooled chillers.
- The thermal fluid used by you must be chosen in such a way that it not only allows the minimum and maximum working temperature but is also suitable as regards the fire point, boiling point and viscosity. In addition, the thermal fluid must be compatible with all the materials in your system.

INFORMATION

For water-cooled temperature control units, please take the cooling water temperature necessary for perfect operation and the required differential pressure from the data sheet. → From page 71, section »Annex«.

3.4 “Pilot ONE®” controller

Please note the figure “Pilot ONE”. → Page 6.

The basic version of “Pilot ONE” (Basic) can be upgraded in three stages (from “Basic” to “Exclusive”, from “Exclusive” to “Professional”, and from “Professional” to “Explore”).

3.4.1 Functional overview of “Pilot ONE®”

You can verify, and optionally upgrade, the delivery version of your temperature control unit using Pilot ONE, category “E-grade”.

Overview of the E-grade variants

Temperature control units / E-grade	E-grade Basic	E-grade Exclusive	E-grade Professional
Brewing thermostats	–	X	O
Unistat temperature control units	–	–	X
UniCAL	–	–	X
Other temperature control units	X	O	O
E-grade “Explore” (only for “Unistat”-series temperature control units) The E-grade includes E-grade “Professional” functionalities. In addition it includes: – Sensor calibration for return sensor – Return temperature display – Display of performance (estimated or calculated from volume flow) – Display mode “Explore” instead of “numerically large” – PB commands correspond to DV-E-grade, except: Temperatures only in 0.01 °C and volume flows only in 0.1 l/min.	–	–	O
E-grade “DV-E-grade” – All interface commands are enabled. – Temperatures in 0.001 C, volume flows in 0.001 l/min possible (cf. E-grade Explore) Note: Only the interface commands are enabled, not the corresponding menu items in Pilot ONE!	O	O	O
E-grade “OPC-UA” – OPC-UA interface via Ethernet. This E-grade additionally includes DV-E-grade functionalities.	O	O	O
X = Standard equipment, O = optional, – = not possible			

Overview of E-grade functions

Function	E-grade Basic	E-grade Exclusive	E-grade Professional
Temperature control			
Controller parameterization: predefined ¹ / TAC ²	X/–	–/X	–/X
Find parameters: Fast Identification / With Preliminary Test / Estimate Control Parameters	–/–/X	X/X/–	X/X/–
Sensor calibration for control sensor ³ : x -point	2	5	5
Monitoring: Low level and overtemperature ⁴	X	X	X
Adjustable alarm thresholds	X	X	X
VPC ¹ (Variable Pressure Control)	X	X	X

¹ TAC function available as a 30 day evaluation version.

² True Adaptive Control.

³ Internal Pt100 and External Pt100.

⁴ For temperature control units with integrated overtemperature protection.

Function	E-grade Basic	E-grade Exclusive	E-grade Professional
Ventilation program	X	X	X
Automated compressor	X	X	X
Setpoint limitation	X	X	X
Program controller: x programs / max x steps	-/-	3/15	10/100
Ramp function: linear / non-linear	-/-	X/-	X/X
Temperature control mode: Internal and process	-	X	X
Adjustable max. heating and cooling capacity	-	X	X
Display & operation			
Temperature display: 5.7" Touchscreen	X	X	X
Display mode: graphically / numerically large / Explore	-X/-	-X/-	X/X/-
Display resolution: 0.1 °C / 0.01 °C	X/-	X/X	X/X
Graphic display for temperature curves: Window, full screen and scalable	X	X	X
Calendar, date and time	X	X	X
Language: CZ, DE, EN, ES, FR, IT, JP, KO, PL, PT, RU, TR, ZH	X	X	X
Temperature format switchable: °C, °F and K	X	X	X
Display mode (screen) can be switched by swiping	X	X	X
Favorites menu	X	X	X
User menu (Administrator Level)	-	-	X
2. Setpoint	-	-	X
Connections			
Digital interface RS232	X	X	X
USB interfaces: Host und Device	X	X	X
Ethernet RJ45 interface	X	X	X
Pt100 external sensor connection	-	X	X
External control signal (ECS STANDBY ²)	X	X	X
Programmable potential-free contact (ALARM ³)	X	X	X
AIF (Analog Interface) 0/4–20 mA or 0–10 V ⁴	X ⁵	X	X
Digital interface RS485 ⁶	X	X	X
Comfort & other			
Visual / audible alarm signal	X	X	X
Autostart (Power Failure Auto)	X	X	X
Plug & Play technology	X	X	X
Technology glossary	X	X	X

¹ For units with variable-speed pump or external bypass.

² Standard on Unistats, otherwise via optional Com.G@te or POKO/ECS interface.

³ Standard on Unistats, otherwise via optional Com.G@te or POKO/ECS interface.

⁴ Via optional Com.G@te.

⁵ Restricted, see entries under "Temperature Control".

⁶ Via optional Com.G@te.

Function	E-grade Basic	E-grade Exclusive	E-grade Professional
Remote control / data visualization via Spy software	X	X	X
E-grade evaluation versions available (valid for 30 days)	X	X	X
Storage/loading temperature control programs onto USB stick	–	X	X
Copying settings	–	–	X
Service data recorders (flight recorder)	X	X	X
PB commands ¹	X	X	X
Communication Watchdog	–	–	X
Process data recording directly to a USB stick: Setpoint, Actual Value Internal and Actual Value Process / Heating Capacity %, Cooling Capacity %, and Pump Pressure / Pump Speed, and VPC Pressure	–/–/–	X/X/–	X/X/X
Calendar start	–	–	X

3.5 Clock/event function

3.5.1 Rechargeable accumulator

“Pilot ONE” is fitted with a clock that continues to run even when the temperature control unit is switched off. The energy required for this purpose is provided by a rechargeable accumulator, which is automatically charged when the temperature control unit is switched on. The accumulator is dimensioned so that the clock can also continue to run for prolonged switch-off intervals (up to several months). If, after extremely prolonged switch-off time, time and date have been deleted, leaving the temperature control unit switched on for a few hours will usually suffice (no temperature control required). During this time, you can reset the time and date.

If after switching the unit off and back on again, the previously set time and date re-appear, it can be safely assumed that the rechargeable accumulator is defective. In this case, please contact Customer Support. → Page 70, section »Contact data«.

3.5.2 Programmable event function

The “Calendar Start” offers a programmable event function. This enables you to enter a time at which the event is repeatedly triggered on a daily basis (until the activity in the menu is reset). 2 event types are currently selectable:

3.5.2.1 Event function “Alarm clock event”

Several acoustic signals are used.

3.5.2.2 Event function “Program event”

After selecting “Program event” when configuring the event function, you will be prompted for the number of the program to be started. The program will be started automatically when the programmed event time is reached. If the temperature control unit is not active, this will also be started.

3.6 Operation via the touch screen

The entire operation is via the >Touchscreen< [88]. These functions can be activated by tapping the displayed text boxes/icons once. This also changes the display.

¹ See Data Communication Manual. Anything controllable via the graphical user interface of the Pilot ONE can be controlled by PB commands.

INFORMATION

You can cancel the current dialog or dialog sequence at any time by pressing the “ESC” touch button. When canceling a dialog or dialog sequence, it may be necessary to confirm the cancellation again. When canceling a dialog sequence, settings made earlier in the dialog sequence are discarded. Check your already carried out settings and re-enter as needed.

3.7 Display instruments

Display instruments

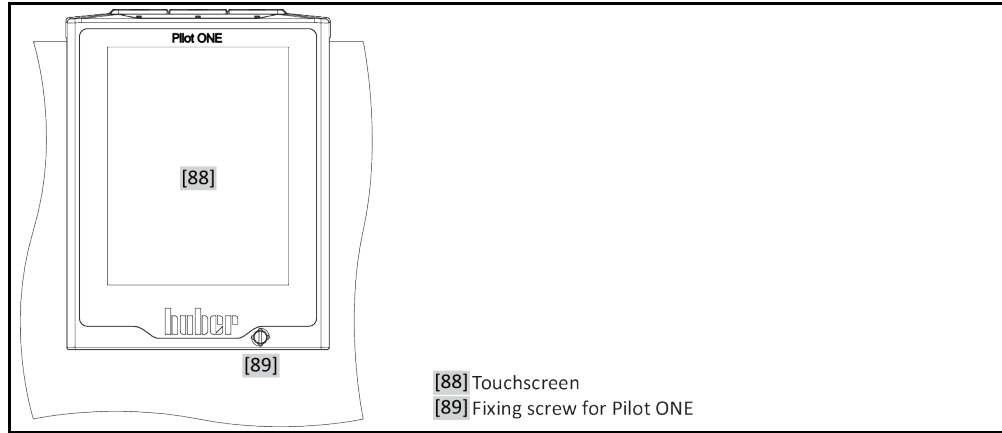

[88] Touchscreen
[89] Fixing screw for Pilot ONE

The following meters are available:

- >Touchscreen< [88]

3.7.1 The touchscreen [88]

The most important display and operating instrument. Shows both standard variables (setpoint, actual value, setpoint thresholds...), and also menu guidance, error information output and operation.

3.8 Control instruments

Example “Control instruments”

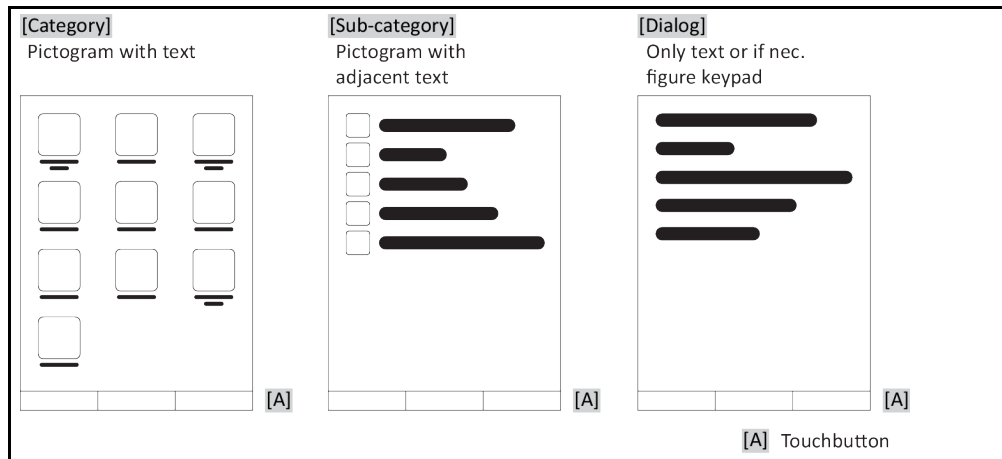

[A] Touchbutton

INFORMATION

To exit the “Categories Menu”, sub-categories, menu items, press the “Home” touch button (house) or the arrow. After 2 minutes of inactivity, the category/ sub-category or the Favourites menu is automatically closed and you return to the “Home” screen. Dialogs are **not** canceled/closed after 2 minutes of inactivity.

3.8.1 The touchbuttons

Depending on the situation, the touch buttons can be assigned different functions. For example:

- Select the “Home” screen (house)
 - Back (arrow to left)
 - Favourites (star)
 - Add to favorites (star with a plus sign)
 - Select the “Categories menu” (menu)
 - Confirm entry
 - Start/stop
- etc.

3.8.2 The categories

For clarity we have grouped the Operation and Setting of Pilot ONE in various categories. A category is selected by tapping it.

3.8.3 The sub-categories

The sub-categories are parts of a category. This is where you will find the entries that we have grouped together for you in the selected category. Not all the categories also contain sub-categories. Tap on a sub-category to select it.

3.8.4 The dialogs

Tapping on a category or sub-category displays its dialogs. Dialogues may appear e.g. as text, a numeric or a alphanumeric keyboard. Dialogs allow you for example to enter settings or start created temperature control programs. Within a dialog, selection must always be confirmed with the “OK” touch button. When cancelling a dialog with the “ESC” touch button it may be necessary to confirm the cancellation again.

3.9 Function examples

3.9.1 Display of software version

PROCEDURE

- Go to the “Categories Menu”.
- Tap on the category “System Settings”.
- Tap on the category “System Info”.
- Tap on the sub-category “Software Version”.

The software versions of the electronics will be displayed:

Display of software versions

Device name	Operating temperature range
Serial number: xxxxx	
Load Code: xxxxxxxx	
Create Code: xxxxxxxx	
Pilot version: xxxxxxxx.xx.xxxxxxx.x	
jjjj-mm-tt 00:00:00	
Serial number: xxxxxxx	
OS version: x.x	
CAN controller: Vxx.xx.xxx	
Bootloader version: xxxxxxxx.xx.xxxxxxx.x	
Active Board: Vxx.xx.xxx	
mmm tt jjjj 00:00:00	
Serial number: xxxxxxx	
Active Board bootloader revision: x.x	

- Tap either the “ESC” or “OK” touchbutton. You will be returned to the previous screen.
- Tap on the “Home” touchbutton (house) to return to the “Home” screen.

3.9.2 Start & Stop

How to start and stop the temperature control process. Prerequisites: You have entered a setpoint.

PROCEDURE

- Go to the “Home” screen.

Start

- Tap on the “Start” touchbutton.
- Confirm the start of temperature control by tapping on “OK”. The correct selection will be displayed graphically and temperature control will start immediately. If tapping on “OK” is not correct, this is displayed graphically for 2 seconds. After this, the display will return to the “Home” screen again. Try to start the temperature control unit again.

Stop

- Tap on the “Stop” touchbutton.
- Confirm the stop of temperature control by tapping on “OK”. The correct selection will be displayed graphically and temperature control will stop immediately and the pump with overrun for about 30 seconds. Wait until the pump stops. If tapping on “OK” is not correct, this is displayed graphically for 2 seconds. After this, the display will return to the “Home” screen again. Try to stop the temperature control unit again.

INFORMATION

With the “Stop” touchbutton, you can also stop Degassing, Venting and Circulation. The requirement for this is that the corresponding task is active.

3.9.3 Copying the settings to a data carrier

Only valid for E-grade Professional

The current settings of the temperature control unit are saved as a file to a connected USB flash drive. Use this file to restore the settings of a temperature control unit or to copy them to another temperature control unit. The models of the temperature control units used must be identical to copy the settings between temperature control units. You cannot transfer data between different models.

You can also transfer the set value of the overtemperature protection to another temperature control unit. You must **always** verify this value on the respective temperature control unit and adjust it if necessary. Make sure that the value of the overtemperature protection has been adapted to the thermal fluid used.

3.9.3.1 Saving to a USB flash drive

PROCEDURE

- Insert a USB flash drive into the “USB 2.0 interface host”. The USB flash drive must have at least 1 MB of free space.
- Go to the “Categories Menu”.
- Tap on the category “System Settings”.
- Tap on the category “Copy Settings”.
- Tap on the dialog entry “Save to USB flash drive”.
- Confirm your choice by tapping on “OK”. The content of the USB flash drive is displayed. If necessary, select the location (folder) on the USB flash drive.
- Confirm the selection of the memory location by tapping on “OK”.
- Enter a name for the file to be saved. Confirm the entry by tapping on “OK”. Alternatively, you can accept the proposed name by tapping on “OK”.
- Read the message and confirm by tapping on “OK”. The file with the settings was created on the USB flash drive.
- Remove the USB flash drive from the temperature control unit.

3.9.3.2 Loading from a USB flash drive

PROCEDURE

- Insert a USB flash drive with the saved file into the “USB 2.0 interface host”.
- Go to the “Categories Menu”.
- Tap on the category “System Settings”.
- Tap on the category “Copy Settings”.
- Tap on the dialog entry “Load from USB flash drive”.
- Confirm your choice by tapping on “OK”. The content of the USB flash drive is displayed.
- Select the file you want to load.
- Confirm the selection of the file by tapping on “OK”.
- Select the setting group to be loaded from the list. A multiple selection is possible.
- Confirm your choice by tapping on “OK”.
- Read the message on the >Touchscreen< [88].
- Switch off the temperature control unit. The settings have been loaded to the temperature control unit.
- Remove the USB flash drive from the temperature control unit.

3.9.4 Restore factory settings

Use this function to reset the temperature control unit to various basic states. This is useful if you want to reverse various settings relatively quickly.

INFORMATION

Restoring the factory settings is **only** possible if the temperature control unit is **not** carrying out a task. If a task is active, do not switch off the temperature control unit until the application allows this. Restoring the factory settings cannot be revoked. Depending on the type of resetting to factory settings performed you may have to enter parameters (process safety, thermal fluid used, cut-out value etc.) again.

“X” = Value is reset, “-” = Value is not reset

(A) = All together; (B) = Device parameters without OT; (C) = Device Parameter; (D) Program Controller; (E) = Menu; (F) = Com.G@te

Description	(A)	(B)	(C)	(D)	(E)	(F)
Acoustics	X	X	X	-	-	-
Display functions Warnings; Messages; Inactive Menu Items; Resolution Temperature	X	X	X	-	-	-
Display modes	X	X	X	-	-	-
AutoStart response	X	X	X	-	-	-
Limitations DeltaT limit; max. heating variable; max. cooling variable; max. permissible current consumption (for 230 V temperature control units)	X	X	X	-	-	-
Com.G@te (only if Com.G@te is connected) Analog Interface (configuration input)						
Meaning of AIF input; response on cable break; measurement range setting	X	X	X	-	-	X
Calibration	-	-	-	-	-	X
In case of analog error; current / voltage switching; filter constant	X	X	X	-	-	X
Configuration Output AIF output variable; Output range setting	X	X	X	-	-	X
Calibration	-	-	-	-	-	X
RS232/RS485 (Hardware RS, Baud rate, device address); ECS Standby; POKO Alarm	X	X	X	-	-	-
Properties (other) Change thermal fluid (thermal fluid, liter indicator, bypass usage); cooling bath / cooling (CC-E only)	X	X	X	-	-	-

Description	(A)	(B)	(C)	(D)	(E)	(F)
Sensor calibration	–	–	–	–	–	–
Automated compressor	X	X	X	–	–	–
Enter program	X	–	–	X	–	–
Pump settings Pump speed setpoint; Pump pressure setpoint; Control Mode	X	X	X	–	–	–
Fluid properties Thermal fluid; liter indicator	X	X	X	–	–	–
Configuration manual parameters						
Protective function High Limit Alarm Internal; Low Limit Alarm Internal; High Limit Alarm Process; Low Limit Alarm Process; Hydrostatic Correction; Warning Time Limit (CC-E only); Min. Level (for temperature control units with analogue level sensor); Max. Level (for temperature controllers with analogue level sensor); Freeze Protection (optional)	X	X	X	–	–	–
Setpoint	X	X	X	–	–	–
Setpoint limitation Min. Setpoint; Max. Setpoint	X	X	X	–	–	–
Language	X	X	X	–	–	–
Temperature format	X	X	X	–	–	–
Temperature control mode	X	X	X	–	–	–
Favourites menu	X	–	–	–	X	–
Pilot ONE Ethernet IP address; Subnet Mask; Remote Access	X	X	X	–	–	–
Time format	X	X	X	–	–	–
2. Setpoint	X	X	X	–	–	–

3.9.4.1 Restore to factory settings without overtemperature protection

PROCEDURE

- Go to the “Categories Menu”.
- Tap on the category “System Settings”.
- Tap on the category “Factory Settings”.
- Choose between the dialog entries “Unit Control Data without OT”, “Menu”, “Programmer” and “Com.G@te”. These entries do **not** restore the overtemperature protection. Tap on the required dialog entry.
- Tap on the “OK” touchbutton to confirm your choice.
- Read the message displayed. Tapping on “Yes” restores the factory settings, tapping on “No” cancels the procedure. The message “Restart system!” appears on the >Touchscreen< [88].
- Switch the temperature control unit off. The selected control data have been reset.

3.9.4.2 Restore to factory settings including overtemperature protection

PROCEDURE

- Go to the “Categories Menu”.
- Tap on the category “System Settings”.
- Tap on the category “Factory Settings”.
- Choose between the dialog entries “Unit Control Data” and “All together”. These entries **also** reset the overtemperature protection. Tap on the required dialog entry.
- Tap on the “OK” touchbutton to confirm your choice.
- Read the message displayed. Tapping on “Yes” restores the factory settings, tapping on “No” cancels the procedure.

INFORMATION

In the following dialog, enter the overtemperature protection suitable to the thermal fluid used. To reset the cut-out values of the overtemperature protection to the factory setting from within the controller of Pilot ONE, enter for "Heater" 35 °C and for the expansion vessel 45 °C. "Process Safety" is factory set to "Stop" and is automatically reset to "Stop" when restoring the factory settings.

- Enter the temperature unit you want to use with Pilot ONE. The available choices are "Celsius (°C)", "Kelvin (K)" and "Fahrenheit (°F)".
- Confirm your choice by tapping on "OK".
- Read the message and confirm by tapping on "OK".
- Read the safety warning and confirm by tapping on "OK".
- Read the Note and confirm by tapping on "OK".
- Tap on the temperature format set by you in the controller (green text).
- Enter the displayed red safety code using the numeric keypad that appears.
- Enter the value 35 °C for the "Heating OT value" using the numeric keypad that appears.
- Confirm your entry by tapping on "OK".
- Read the message and confirm by tapping on "OK".
- Read the safety warning and confirm by tapping on "OK".
- Tap on the temperature format set by you in the controller (green text).
- Enter the displayed red safety code using the numeric keypad that appears.
- Enter the value 45 °C for the "Exp. vessel OT value" using the numeric keypad that appears.
- Confirm your entry by tapping on "OK". The message "Restart system!" appears on the >Touchscreen< [88].
- Switch off the temperature control unit. The temperature control unit is reset.

4 Setup mode

4.1 Setup mode

CAUTION

Moving the temperature control unit during operation

SERIOUS BURNS/FREEZING OF THE HOUSING PARTS/ESCAPING THERMAL FLUID

➤ Do not move temperature control units that are in operation.

4.1.1 Turning on the temperature control unit

PROCEDURE

- Turn on the temperature control unit using the **>Mains switch<** [37].
First, a system test is conducted to test the full functionality of the temperature control unit. All sensors, the all-pole disconnecting power disconnect relay for the power supply and the power electronics of the main heater and the main heater itself are checked. A message appears on the **>Touchscreen<** [88] in case of an error or if a warning is issued. In case of doubt, please contact Customer Support. → Page 70, section **»Contact data«**.

INFORMATION

The following data entry is required only for:

- a.) Initial start-up
- b.) resetting the temperature control unit to the factory settings. → Page 38, section **»Restore factory settings«**.

- After switching on the temperature control unit, tap on the required system language.
- Touch "OK" to confirm your selection.
- Tap on the thermal fluid used.
- Touch "OK" to confirm your selection.
- Read the message and confirm by tapping on "OK".
- Enter the volume using the number keypad that appears.
- Touch "OK" to confirm your entry.
- Set the setpoint limits to the thermal fluid used. → Page 30, section **»Information on the thermal fluids«** and → Page 51, section **»Setting the setpoint thresholds«**.

INFORMATION

If your temperature control unit is not integrated into a network, confirm the preset IP address (0.0.0.0) by tapping on "OK". This skips the network settings.

- Enter the required IP address using the number keypad that appears.
- Confirm your entry by tapping on "OK".
- Enter the required Subnet Mask using the number keypad that appears.
- Confirm your entry by tapping on "OK".
- Tap on the required remote control mode.
- Confirm your choice by tapping on "OK".

4.1.2 Turning off the temperature control unit

PROCEDURE

- Warm the thermofluid to room temperature.
- Stop the thermoregulation.
- Switch off the temperature control unit using the **>Mains switch<** [37].

4.1.3 Setting the overtemperature protection



The overtemperature protection is not correctly set to the thermal fluid used

MORTAL DANGER FROM FIRE

- The overtemperature protection must be correctly set to the thermal fluid you are using.
- Always observe the safety data sheet of the thermal fluid.
- Different working temperature ranges may apply for open and closed systems.
- **For Huber thermal fluids:**
- For Huber thermal fluids, the maximum usable working temperature range is already indicated.
- Set the cut-out value of the overtemperature protection to the **upper temperature limit of the working range** of the thermal fluid.
- **For thermal fluids of other manufacturers:**
- Set the cut-out value of the overtemperature protection at least **25 K below the fire point** of the thermal fluid.

INFORMATION

The maximum settable cut-out value of the OT corresponds, for Huber thermal fluids, to the specified upper working temperature of the thermal fluid. The usable working temperature range may be less, if the overtemperature protection is correctly set. When controlling the temperature at the upper working temperature limit, the OT may be triggered due to tolerances.

4.1.3.1 General information on the overtemperature protection

The overtemperature protection is a device in the temperature control unit that works independently of the controller. The software and hardware is designed to test key functions and operating states during a self-test after the power supply has been switched on. If faults are detected, the enabling of the electrical assemblies in the temperature control unit is blocked. During operation, the sensors are tested for short-circuit and interruption.

The bath or flow temperature is monitored to ensure the safety of your system. It is set immediately after you have filled the system with thermal fluid.

Our temperature control units not only offer the possibility to specify the cut-out value of the overtemperature protection but also provide the possibility to specify the shutdown mode of the temperature control unit. In a typical setting the temperature control unit switches off both the temperature control as well as the circulation (**stop according to DIN EN 61010**) after reaching the cut-out value. This monitors a possible defect in the control of the heater. A strong exothermic reaction near the cut-out value can also, under certain circumstances, result in a shutdown of the temperature control unit. In this case, however, a shutdown would be fatal.

Our temperature control units provide the possibility to work with the shutdown mode **Process Safety**. In this mode, temperature control (cooling) and circulation work as always. This is therefore a possibility to respond to exothermic reactions.

INFORMATION

The default shutdown mode of the overtemperature protection is **“Stop according to DIN EN 61010”**. When resetting to factory settings, the overtemperature protection is **reset** to the default shutdown mode **“Stop according to DIN EN 61010”**!

Upon delivery, the cut-out value of the overtemperature protection is set to 35 °C. An alarm is triggered by the temperature control unit shortly after turning on the power if the temperature of the thermal fluid just filled is higher than the cut-out value set for the overtemperature protection. Set the overtemperature protection to the thermal fluid you are using.

When setting a new cut-out value for the overtemperature protection, you will be prompted to enter a randomly generated and displayed code via the numeric keypad displayed. Only after successful entry will you be able to change the cut-out value.

4.1.3.2 Setting “OT limit: heating”

PROCEDURE

- Go to the “Categories Menu”.
- Tap on the category “Safety”.
- Tap on the category “Overtemperature”.

- Read the safety warning and confirm by tapping on “OK”.
- Read the Note and confirm by tapping on “OK”.
- Tap on the dialog entry “OT limit: heating”.
- Confirm your choice by tapping on “OK”.
- Tap on the temperature format set by you in the controller (green text).
- Enter the displayed red safety code using the number keypad that appears.
- Enter the value for the “Heating OT value” using the numeric keypad that appears. This value must be 25 K below the fire point of the thermal fluid you are using.
- Confirm your entry by tapping on “OK”.

4.1.3.3 Setting “Process Safety”

You have two options.

“Stop” in accordance with DIN EN 61010

Once the overtemperature protection cut-out value is reached, the temperature control unit (heating, cooling circuit and circulation pump) switches off (default setting).

“Process Safety”

Once the overtemperature protection cut-out value is reached, the heater switches off and the cooling circuit and circulation pump continue to operate. In case of an emergency (possible exothermic reaction), the full cooling capacity is thus available. Please make sure that the automated compressor is set to **Permanently ON** ([System Settings] > [Power/ECO Settings] > [Compressor ON/OFF/AUTO] > [Permanently ON]).

PROCEDURE

- Go to the “Categories Menu”.
- Tap on the category “Safety”.
- Tap on the category “Process Safety”.
- Read the safety warning and confirm by tapping on “OK”.
- Choose between the modes “Stop” and “process safety”.
- Confirm your choice by tapping on “OK”.

4.1.3.4 Monitoring via “Display OT values”

PROCEDURE

- Go to the “Categories Menu”.
 - Tap on the category “Safety”.
 - Tap on the category “Display OT values”.
- You will receive an overview of the current measured temperature value of the overtemperature protection sensor, the set cut-out values and the set cut-out mode (Process Safety). Some temperature control units have 2 overtemperature protection sensors, and so 2 values are shown for these temperature control units.
- Tap on the “OK” touchbutton after you have read/checked the information.

4.1.4 Testing overtemperature protection for functionality



DANGER

Overtemperature protection (OT) does not trip

MORTAL DANGER FROM FIRE

- Test the response of the device every month and after each change of the thermal fluid in order to assure proper functioning.

NOTE

**The steps below are carried out without permanent monitoring of the temperature control unit
DAMAGE TO AND IN THE VICINITY OF THE TEMPERATURE CONTROL UNIT**

- The following actions may only be carried out while constantly monitoring the temperature control unit and the application!

INFORMATION

Run the test only if the temperature of the thermal fluid used is about 20 °C. You must **NOT leave the temperature control unit unattended** during the entire test of the overtemperature protection.

The Pilot ONE controller contains a description for carrying out the overtemperature protection test.

PROCEDURE

- Go to the "Categories Menu".
- Tap on the category "Safety".
- Tap on the category "OT Test".
 - The description for carrying out the overtemperature protection test is displayed.
- Tap on the "OK" touch button after you have read the information.

4.2 The temperature control circuit

For many temperature applications it is sufficient to use the factory-set control parameters. Our years of experience and current developments in control technology are used in these control parameters.

If a process control system is used, ideally send the specification of the temperature setpoint digitally to the temperature control unit. For this purpose, an Ethernet and USB port is available at the Pilot ONE and a RS232 interface at the temperature control unit. With the optional Com.G@te, an additional RS485 interface is added to your temperature control unit. Optionally you can integrate the temperature control unit in a Profibus environment. → From page 58, section »Interfaces and software update«.

INFORMATION

The capacity adjustment of the temperature control unit is optimized so that the specified processes are run through in the fastest possible time. This increases the productivity of the system as a whole and thus saves energy in the long term.

4.2.1 Selecting the temperature control: Internal

PROCEDURE

- Go to the "Categories Menu".
- Tap on the category "Temperature Control".
- Tap on the category "Process/Internal".
- Select the dialog entry "Internal".
- Confirm your choice by tapping on "OK".

4.2.2 Temperature control to internal temperature

With internal temperature control, a control circuit is used to control the temperature at the internal Pt100 temperature sensor. This Pt100 temperature sensor is built into the device and is located close to thermal fluid outlet (forward flow) or in the bath tank.

Representation of an optimum internal temperature control

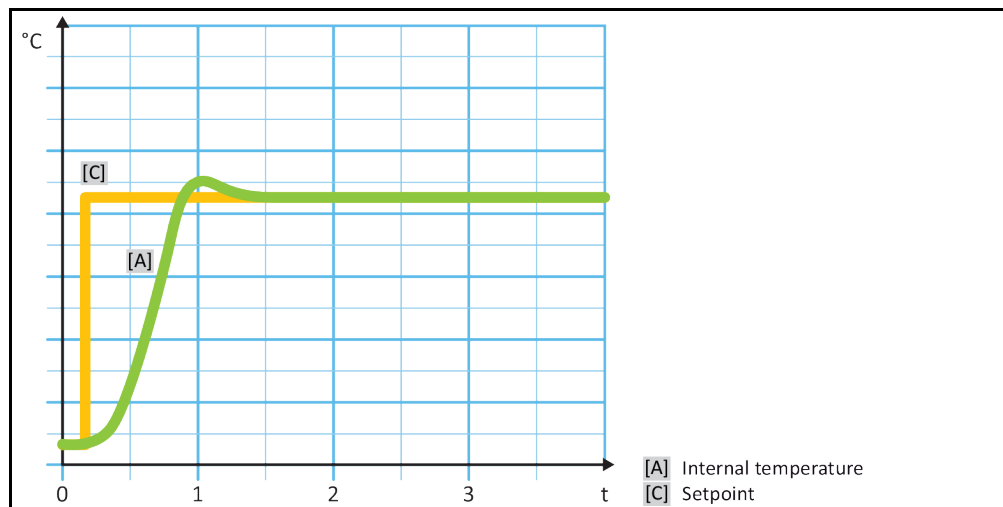

4.2.3 Optimum control parameters for optimum temperature control

If the adjustment of the temperature does not correspond to the quality of the illustrations shown above, you can adjust the control parameters. With Huber temperature control units, there are various ways of finding the optimum control parameters. Depending on the facilities of the temperature control unit, you can choose the following processes:

- Use ex-factory parameters (standard)
- Estimate Control Parameters (only useful for bath thermostats with E-grade Basic and internal control)
- Fast Identification (from E-grade Exclusive)
- With Preliminary Test (from E-grade Exclusive)

4.2.4 Sub-category: "Select auto/expert mode".

NOTE

Use of the "Expert mode" without a thorough knowledge of I&C technology.

MATERIAL DAMAGE TO THE APPLICATION

➤ Only use this mode if you have a thorough knowledge of I&C technology.

Here you can select whether the control parameters are set in the "Automatic mode" or in the "Expert mode". To enter settings in "Expert mode" requires in-depth knowledge of process measuring and control technology. Incorrect or insufficient settings can severely impair the function of the temperature control unit.

INFORMATION

In "Expert mode", "Configuration auto" is deactivated and only "Configuration manual" is possible.

This is how to change mode:

PROCEDURE

- Go to the "Categories Menu".
- Tap on the category "Temperature Control".
- Tap on the category "TAC/Manual".
- Tap on the sub-category "Select auto/expert".
- Choose between the dialog entries "Automatic mode" and "Expert mode".
- Confirm your choice by tapping on "OK".

4.2.5 Sub-category: "Configuration auto"

INFORMATION

You can only select this menu entry if "Automatic mode" is set.

4.2.5.1 Sub-category: "Find parameters"

4.2.5.1.1 Dialog entry: "Fast Identification"

Considering the small effort, the "Fast Identification" function of the controlled system provides you with very quick and reliable adapted control parameters. These control parameters achieve a fast and very accurate tuning performance. The more complex but also more precise identification "With Preliminary Test" is only very rarely required.

INFORMATION

Do not make any changes to the temperature control unit and to the application (temperature control unit / external application) after your system has been started. Changes include e.g. filling / draining process chamber, changing the mixer speed etc.

PROCEDURE

- Before setting the control parameters, make sure that the temperature control unit has reached the set setpoint and has been controlling the temperature at this setpoint for a few minutes. Do not stop the temperature control.

- Do not make any changes to the temperature control unit and the application during parameter determination.
- Go to the “Categories Menu”.
- Tap on the category “Temperature Control”.
- Tap on the category “TAC/Manual”.
- Tap on the sub-category “Configuration auto”.
- Tap on the sub-category “Find parameters”.
- Tap on the dialog entry “Fast Identification”.
- Confirm your choice by tapping on “OK”.
- Read the message displayed and confirm it by tapping on “OK”.
- Select the thermal fluid used from the list.
- Confirm your choice by tapping on “OK”.
- Select the dialog entry “Internal”.
- Confirm your choice by tapping on “OK”.
- Enter a new setpoint using the numeric keypad that appears. It should be at least 10 K away from the current setpoint.
- Confirm your entry by tapping on “OK”. Setting of the control parameters using “Fast Identification” starts and after a while a message appears on the display.
- Read the message displayed and confirm it by tapping on “OK”.

4.2.5.1.2 Dialog entry: “With Preliminary Test”

In some complex applications, the “Fast Identification” of the control circuit may not yet lead to optimum control. This can happen, in particular, if the hydraulic build-up cannot be adjusted to the necessary circulation volumes. → Page 31, section »**To be noted when planning the test**«.

A further optimization of control behavior can be achieved if you select the control parameterization “With Preliminary Test”. With this, the control parameters within the set limits of the minimum and maximum setpoint are determined. Temperature control is then also carried out to the setpoint limits in some circumstances.

INFORMATION

Before starting the automatic controller parameterization, verify the correct setting of the minimum and maximum setpoint. A limitation to the actually used operating temperature range is advantageous. Do not make any changes to the temperature control unit and to the application (temperature control unit / external application) after your system has been started. Changes include e.g. filling / draining process chamber, changing the mixer speed etc.

Since the working temperature range can sometimes be very large, finding the parameters takes correspondingly longer in this mode. The control defines up to three temperature setpoints and automatically processes them one after another. One of these is below room temperature, one roughly at room temperature and one above room temperature, if the setpoint limits allow this.

PROCEDURE

- Before setting the control parameters, make sure that the temperature control unit has reached the set setpoint and has been controlling the temperature at this setpoint for a few minutes. Do not stop the temperature control.
- Do not make any changes to the temperature control unit and the application during parameter determination.
- Go to the “Categories Menu”.
- Tap on the category “Temperature Control”.
- Tap on the category “TAC/Manual”.
- Tap on the sub-category “Configuration auto”.
- Tap on the sub-category “Find parameters”.
- Tap on the dialog entry “With Preliminary Test”.
- Confirm your choice by tapping on “OK”.
- Read the message displayed and confirm it by tapping on “OK”.
- Select the thermal fluid used from the list.
- Confirm your choice by tapping on “OK”.
- Select the dialog entry “Internal”.
- Confirm your choice by tapping on “OK”. Setting the control parameters using “With Preliminary Test” starts and a message appears on the touchscreen after a while.
- Read the message displayed and confirm it by tapping on “OK”.

4.2.5.1.3 Dialog entry: "Estimate Control Parameters"

Even with the simple temperature control units, we offer a further advantage in comparison with comparable bath thermostats available on the market. You can modify an existing control parameter by entering the thermal fluid used and the quantity of thermal fluid. This version is available with bath thermostats without connected external application.

INFORMATION

All the necessary technical data for the thermal fluids listed for Pilot ONE are stored in the controller. If the thermal fluid that you use is not shown in the list, choose the most similar thermal fluid with regard to temperature range and viscosity. → Page 30, section »**Information on the thermal fluids**«.

PROCEDURE

- Before setting the control parameters, make sure that the temperature control unit has reached the set setpoint and has been controlling the temperature at this setpoint for a few minutes. Do not stop the temperature control.
- Do not make any changes to the temperature control unit and the application during parameter determination.
- Go to the "Categories Menu".
- Tap on the category "Temperature Control".
- Tap on the category "TAC/Manual".
- Tap on the sub-category "Configuration auto".
- Tap on the sub-category "Find parameters".
- Tap on the dialog entry "Estimate Control Parameters".
- Confirm your choice by tapping on "OK".
- Read the message and confirm it by tapping on "Yes". The current control parameters are being overwritten.
- Select the thermal fluid used from the list.
- Confirm your choice by tapping on "OK".
- Read the message displayed and confirm it by tapping on "OK".
- Enter the filling volume using the number keypad that appears.
- Confirm your entry by tapping on "OK".
- Tap twice on the "Arrow" touchbutton to return to the category "Temperature Control".
- Tap on the category "Process/Internal".
- Select the dialog entry "Internal".
- Tap on "OK" to confirm your choice.

4.2.5.2 Sub-category: "Control Dynamics"

You can choose between a faster tuning performance with a possible and accepted small temperature overshoot and a tuning performance without temperature overshoot. The default setting is "**Fast, small overshoot**".

The overshoot always refers to the leading temperature. In the setting "**Fast, small overshoot**", the combination of high thermal fluid flow rate and the superbly designed control electronics hardly ever results in an overshoot, while reaching the setpoint as quickly as possible. Contrary to the mode "**Fast, small overshoot**" there is the setting "**Without overshoot**". The target temperature is approached more cautiously and thus aperiodically. It takes longer to adjust to the selected setpoint. The statement "without overshoot" is only valid with little external disturbance influence. Please note the specifications. → Page 31, section »**To be noted when planning the test**«.

INFORMATION

The adjustment behavior can be selected at any time without reactivating the "Find control parameters".

Internal, aperiodic temperature control

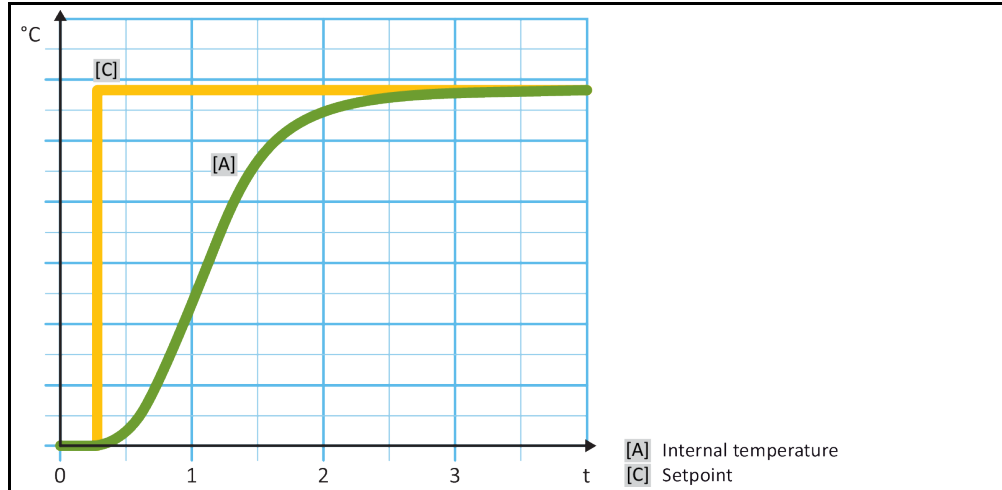

Internal, dynamic temperature control with possible overshooting of the temperature

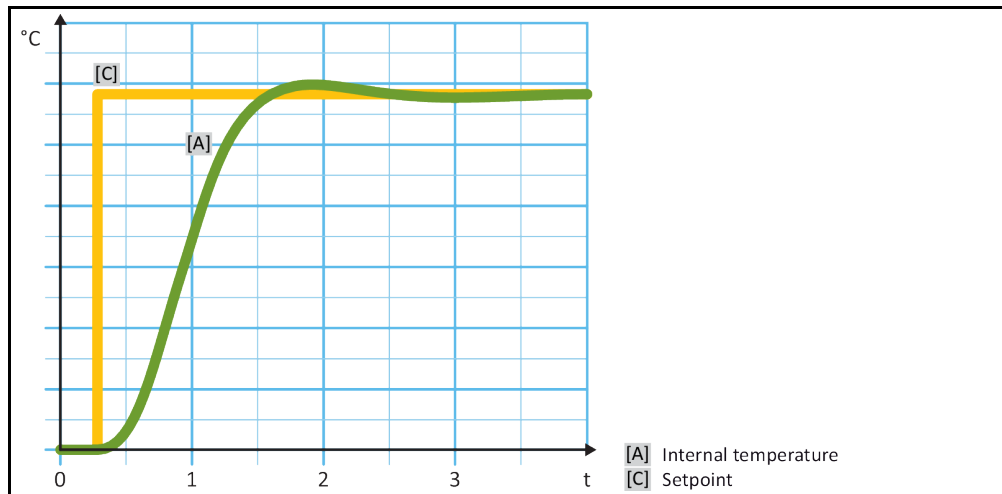

PROCEDURE

- Go to the “Categories Menu”.
- Tap on the category “Temperature Control”.
- Tap on the category “TAC/Manual”.
- Tap on the sub-category “Configuration auto”.
- Tap on the sub-category “Control Dynamics”.
- Choose between the dialog entries “Fast, small overshoot” and “Without overshoot”.
- Confirm your choice by tapping on “OK”.

4.2.5.3 Sub-category: “Fluid Properties”

4.2.5.3.1 Sub-category “Select Fluid”

Under this entry, you can select the thermal fluid used from a list.

PROCEDURE

- Go to the “Categories Menu”.
- Tap on the category “Temperature Control”.
- Tap on the category “TAC/Manual”.
- Tap on the sub-category “Configuration auto”.
- Tap on the sub-category “Fluid Properties”.
- Tap on the sub-category “Select Fluid”.
- Select the thermal fluid used from the list.
- Confirm your choice by tapping on “OK”.

4.2.5.3.2 Sub-category: "Bath/Circulation Volume"

Under this entry, you can enter the filling volume of the thermal fluid in your bath/circuit.

PROCEDURE

- Go to the "Categories Menu".
- Tap on the category "Temperature Control".
- Tap on the category "TAC/Manual".
- Tap on the sub-category "Configuration auto".
- Tap on the sub-category "Fluid Properties".
- Tap on the sub-category "Bath/Circulation Volume".
- Read the message and confirm it by tapping on "OK".
- Enter the filling volume using the number keypad that appears.
- Confirm your entry by tapping on "OK".

4.2.5.3.3 Sub-category: "Show Fluid"

This entry provides you with an overview of the settings entered.

PROCEDURE

- Go to the "Categories Menu".
- Tap on the category "Temperature Control".
- Tap on the category "TAC/Manual".
- Tap on the sub-category "Configuration auto".
- Tap on the sub-category "Fluid Properties".
- Tap on the sub-category "Show Fluid".
- Tap on "OK" after you have read/checked the entries.

4.2.5.4 Sub-category: "Display parameters"

Here you can display the set parameters in "Automatic mode".

PROCEDURE

- Go to the "Categories Menu".
- Tap on the category "Temperature Control".
- Tap on the category "TAC/Manual".
- Tap on the sub-category "Configuration auto".
- Tap on the sub-category "Display parameters".
- Tap on "OK" after you have read/checked the parameters.

4.2.6 Sub-category: "Configuration manual"

NOTE

Use of the "Expert mode" without a thorough knowledge of I&C technology.

MATERIAL DAMAGE TO THE APPLICATION

- Only use this mode if you have a thorough knowledge of I&C technology.

INFORMATION

In "Expert mode", "Configuration auto" is deactivated only "Configuration manual" is possible.

To enter settings in "Expert mode" requires in-depth knowledge of process measuring and control technology. Incorrect or insufficient settings can severely impair the function of the temperature control unit.

4.2.6.1 Sub-category: "Change parameters"

Use this menu item to manually configure the control parameters. The control parameters can be entered under the entry "Internal".

4.2.6.1.1 Sub-category: "Internal"

Enter the new values for "KP", "Tn" and "Tv" here one after the other.

PROCEDURE

- Go to the "Categories Menu".
- Tap on the category "Temperature Control".
- Tap on the category "TAC/Manual".
- Tap on the sub-category "Configuration manual".
- Tap on the sub-category "Change parameters".
- Tap on the sub-category "Internal".
- Enter the new "KP" value using the number keypad that appears.
- Confirm your entry by tapping on "OK".
- Enter the new "Tn" value using the number keypad that appears.
- Confirm your entry by tapping on "OK".
- Enter the new "Tv" value using the number keypad that appears.
- Confirm your entry by tapping on "OK".

4.2.6.2 Sub-category: "Display parameters"

In this function, the set manual parameters are displayed.

PROCEDURE

- Go to the "Categories Menu".
- Tap on the category "Temperature Control".
- Tap on the category "TAC/Manual".
- Tap on the sub-category "Configuration manual".
- Tap on the sub-category "Display parameters".
- Tap on "OK" after you have read/checked the parameters.

4.2.6.3 Sub-category: "Control structure"

With this function, you have two different control structures available.

"Huber PID controller": Default setting

"Classic PID controller": This setting is exclusively used by Huber service engineers for service purposes.

PROCEDURE

- Go to the "Categories Menu".
- Tap on the category "Temperature Control".
- Tap on the category "TAC/Manual".
- Tap on the sub-category "Configuration manual".
- Tap on the sub-category "control structure".
- Choose between the dialogue entries "Huber PID controller" and "Classic PID controller".
- Confirm your choice by tapping on "OK".

4.2.7 Sub-category: "Reset parameters"

With this function, you can reset the control parameters to the factory setting.

PROCEDURE

- Go to the "Categories Menu".
- Tap on the category "Temperature Control".
- Tap on the category "TAC/Manual".
- Tap on the sub-category "Reset parameters".
- Read the message and confirm it by tapping on "Yes". The control parameters are reset/deleted.
The temperature control unit can only be operated again after a complete restart.
- To do so, switch the temperature control unit off and back on again. The parameters have been reset.

4.2.8 Sub-category: “Display parameters”

In this function, the set parameters are displayed. Depending on the previous setting, these will be the “Automatic control parameters” or the “Manual control parameters”.

PROCEDURE

- Go to the “Categories Menu”.
- Tap on the category “Temperature Control”.
- Tap on the category “TAC/Manual”.
- Tap on the sub-category “Display parameters”.
- Tap on “OK” after you have read/checked the parameters.

4.2.9 Freeze protection for temperature control unit

NOTE

Non-compliance with the compatibility between the thermal fluid and your temperature control unit

MATERIAL DAMAGE

- Water with a temperature below 0 °C and without an anti-freeze must not be used as a thermal fluid (risk of freezing and potential destruction of the evaporator).
- Water below a temperature of 5 °C must not be used without an anti-freeze as a thermal fluid (risk of freezing and potential destruction of the evaporator).
- Observe the classification of your temperature control unit according to DIN 12876.
- Ensure the following materials are resistant with respect to the thermal fluid: Stainless steel 1.4301/ 1.4401 (V2A), copper, nickel, FKM, red bronze/brass, silver solder and plastic.
- The maximum viscosity of the thermal fluid must not exceed 50 mm²/s at the lowest working temperature!
- The maximum density of the thermal fluid may not exceed 1 kg/dm³!

NOTE

Operation without freeze protection activated

COMPLETE DESTRUCTION OF THE TEMPERATURE CONTROL UNIT

- When using water as a thermal fluid, freeze protection must be activated in the category “protective devices”.

Temperature control units with freeze protection option can use water as the only thermal fluid. Possible danger: Freezing of the heat exchanger at < 5 °C. An ice crystal (green flashing) indicates the activation of the freeze protection on the touch display. To find out whether your temperature control unit is equipped with a freeze protection, refer to the datasheet. → From page 71, section »Annex«.

PROCEDURE

- Go to the “Categories Menu”.
- Tap on the category “Protection Options”.
- Tap on the category “Freeze Protection”.
- Either tap on the dialog entry “off” or “on” to turn the freeze protection on or off.
- Confirm your choice by tapping on “OK”.

4.2.10 Setting the setpoint thresholds

Overview of the temperature thresholds

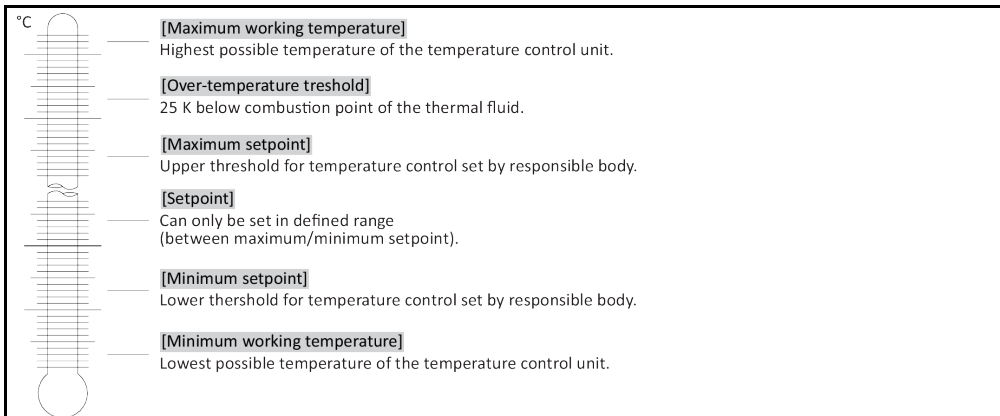

The limits for the minimum and maximum setpoint serve the safety of your system. They **must** be set for the application range of the thermal fluid before starting the first temperature control and when changing the thermal fluid. The maximum setpoint limit limits the setpoint setting for the bath or flow temperature. The minimum setpoint limit protects against high viscosity or freezing at low temperatures. The adjustable setpoint is then only available in the temperature range between the minimum and maximum setpoint limit.

PROCEDURE

- Go to the “Categories Menu”.
- Tap on the category “Protection Options”.
- Tap on the category “Setpoint Limits”.
- Tap on the sub-category “Minimum Setpoint”.
- Enter the new value, using the numeric keypad that appears.
- Confirm your entry by tapping on “OK”.
- In the display that follows, confirm your entry again by tapping on “OK”.
The correct selection will be displayed graphically and the “Min. setpoint” will be changed promptly. If tapping on “OK” is not correct, it will be displayed graphically for 2 seconds. The display will then return to the category “Setpoint Limits”. Try changing the “Min. Setpoint” again.
- Tap on the sub-category “Maximum Setpoint”.
- Enter the new value, using the numeric keypad that appears.
- Confirm your entry by tapping on “OK”.
- In the display that follows, confirm your entry again by tapping on “OK”.
The correct selection will be displayed graphically and the “Max. Setpoint” will be changed promptly. If tapping on “OK” is not correct, it will be displayed graphically for 2 seconds. The display will then return to the category “Setpoint Limits”. Try changing the “Max. Setpoint” again.

INFORMATION

Check the set values for the minimum and maximum setpoint at any system change, especially when changing the thermal fluid.

4.2.11 Setting the setpoint

PROCEDURE

- Go to the “Home” screen.
- Tap on the keypad symbol next to “T_{Setpoint}”.
- Enter a new setpoint using the number keypad that appears.
The following must apply:
[Minimum setpoint limit] ≤ [Setpoint] ≤ [Maximum setpoint limit].
If these conditions are not met, a message will appear on the >Touchscreen< [88] and the entry will be ignored. In this case, delete the value just entered either with the “Arrow” key or with the “clear” key. Enter the setpoint again.
- Confirm your entry by tapping on “OK”.
- In the display that follows, confirm your entry again by tapping on “OK”.
The correct selection will be displayed graphically and the setpoint will be changed immediately. If tapping on “OK” is not correct, this is displayed graphically for 2 seconds. After this, the display will return to the “Home” screen again. Try changing the setpoint again.

4.3 Filling and draining

Observe the wiring diagram. → From page 71, section »Annex«.

CAUTION

Extremely hot / cold surfaces, connections and thermal fluids

BURNS/FREEZING OF LIMBS

- Surfaces, connections and tempered thermal fluids can be extremely hot or cold depending on the operating mode.
- Avoid direct contact with surfaces, connections and thermal fluids!
- Wear your personnel protective equipment (e.g. temperature-resistant safety gloves, safety goggles).

4.3.1 Filling and draining of bath thermostat

CAUTION

Non-compliance with the safety data sheet for the thermal fluid to be used

INJURIES

- Risk of injury to the eyes, skin, respiratory tract.
- The safety data sheet for the thermal fluid to be used must be read prior to using it and its content must be respected.
- Observe the local regulations/work instructions.
- Wear your personal protective equipment (e.g. temperature-resistant safety gloves, safety goggles, safety footwear).
- Danger of slipping because floor and work area are contaminated. Clean the workplace; observe the proper disposal of thermal fluid and aids. → Page 15, section »Proper disposal of resources and consumables«.

NOTE

Thermal fluid flowing over into the temperature control unit

MATERIAL DAMAGE

- Shut down the temperature control unit immediately.
- Isolate the temperature control unit from the power supply.
- Have the temperature control unit only serviced and cleaned by staff trained by Huber. Follow the instructions for the proper disposal. → Page 15, section »Proper disposal of resources and consumables«.

INFORMATION

Overflowing thermal fluid will create a film on surfaces, and therefore must be collected and disposed of immediately after the event in accordance with the safety data sheet. Observe the proper disposal of thermal fluid and aids. → Page 15, section »Proper disposal of resources and consumables«.

If this is not complied with, it is assumed that the temperature control unit does not comply with all requirements of DIN EN 61010-2-010.

4.3.1.1 Filling of bath thermostat

PROCEDURE

- Lift the >Bath cover< [93] from the temperature control unit.
- Using the filling accessories (funnel and/or beaker), carefully fill in suitable thermal fluid. → Page 30, section »Information on the thermal fluids«. While filling, pay attention to any necessary measures such as grounding the containers, funnels and other accessories. Follow the instructions for the proper disposal when cleaning filling accessories. → Page 15, section »Proper disposal of resources and consumables«.
- Switch on the temperature control unit.
- Put the >Bath cover< [93] back onto the bath opening.

INFORMATION

The volume expansion of the thermal fluid depends on the working temperature range you wish to work in. Do not go below the minimum bath level/minimal level when working at the “lowest” working temperature and there should be no overflow from the expansion vessel/temperature control unit when working at the “highest” working temperature. In case of overfilling, drain the excess amount of thermal fluid. → Page 54, section »Draining the bath thermostat«. Check if the thermal fluid can be reused. Follow the instructions for the proper disposal. → Page 15, section »Proper disposal of resources and consumables«.

- In case of overfilling, drain thermal fluid via the >Drain< [8] into a suitable container. → Page 54, section »Draining the bath thermostat«. Check if the thermal fluid can be reused. Follow the instructions for the proper disposal. → Page 15, section »Proper disposal of resources and consumables«.

4.3.1.2 Draining the bath thermostat

CAUTION**Hot or very cold thermal fluid****SEVERE BURNS/FROSTBITE OF LIMBS**

- Before draining, ensure that the thermal fluid has room temperature (20 °C).
- If, at this temperature, the thermal fluid is too viscous to be drained: Control the temperature of the thermal fluid for a few minutes until the viscosity will allow drainage. Never control the temperature of the thermal fluid when the drain is open.
- Danger of burns when draining thermal fluids at temperatures above 20 °C.
- Wear your Personal Protective Equipment for draining.
- Only drain using suitable drainage hose and collecting container. These must be compatible with the thermal fluid and its temperature.

INFORMATION

Not all temperature control units are equipped with the same combination of connections/drains. Skip the step in the procedure if the listed connection / drain is not available on your temperature control unit.

PROCEDURE**Temperature control units without drain valves**➤ **Only valid for temperature control units with the function "Drain":**

For the thermal fluid circuit to be completely emptied, the function "Drain" must be activated. In the event of a water-cooled temperature control unit, this function also opens the control valve in the cooling water circuit, depending on the model. Thus, cooling water consumption can increase during the draining process. Skip the following instructions if the dialog entry "Drain" is not available:

- Tap in succession "Category menu", "Temperature control", "Start/stop".

- Tap on the dialog entry: "Drain".

- Confirm your choice by tapping on "OK".

- Read the message and confirm by tapping on "OK".

- Do **not** confirm the subsequent message by tapping on "OK".

- Have a suitable container ready to catch the thermal fluid from the **>Drain<** [8].
- Remove the knurled screw at the **>Drain<** [8]. The thermal fluid will flow into the container as soon as you have opened the knurled screw.
- Wait until the thermal fluid has drained from the external application via the pump chamber into the container.
- Have another suitable container ready to catch the thermal fluid from the **>Expansion vessel drain<** [9].
- Remove the knurled screw at the **>Expansion vessel drain<** [9]. The thermal fluid will flow into the container as soon as you have opened the knurled screw.
- Wait until the thermal fluid has flown from the expansion vessel into the container.
- Have another suitable container ready to catch the thermal fluid from the **>Residues drain<** [10].
- Remove the knurled screw from the **>Residues drain<** [10]. The remaining thermal fluid will flow from the temperature control unit into the container as soon as you have opened the knurled screw.
- Wait until the thermal fluid has flown out.
- Drain the external application. The description for the draining process can be found in the documents you received with the application.
- Disconnect the external application from the connection **>Circulation flow<** [1].
- Disconnect the external application from the connection **>Circulation return<** [2]. Leave the temperature control unit open for a while to allow it to dry out (without seal cap and without knurled screws).
- Connect the external application with the connection **>Circulation flow<** [1].
- Connect the external application with the connection **>Circulation return<** [2].
- Fit the knurled screw to the **>Residues drain<** [10].
- Fit the knurled screw to the **Expansion vessel drain<** [9].
- Fit the knurled screw to the **>Drain<** [8].
- Remove the containers used to collect the thermal fluid. Check if the thermal fluid can be reused. Follow the instructions for the proper disposal. → Page 15, section »**Proper disposal of resources and consumables**«.
- **Only valid for temperature control units with the function "Drain":**
Read the message on the **>Touchscreen<** [88] and confirm by tapping on "OK". The temperature control unit has thus been emptied. In the event of a water-cooled temperature control unit, the control valve in the cooling water circuit is closed, depending on the model.

5 Normal operation

5.1 Automatic operation

CAUTION

Extremely hot / cold surfaces, connections and thermal fluids

BURNS/FREEZING OF LIMBS

- Surfaces, connections and tempered thermal fluids can be extremely hot or cold depending on the operating mode.
- Avoid direct contact with surfaces, connections and thermal fluids!
- Wear your personnel protective equipment (e.g. temperature-resistant safety gloves, safety goggles).

5.1.1 Temperature control

5.1.1.1 Starting the temperature control process

The temperature control process can be started after filling and complete venting.

PROCEDURE

- Go to the "Home" screen.
- Tap on the "Start" touchbutton.
- Confirm the start of temperature control by tapping on "OK".
The correct selection will be displayed graphically and temperature control will start immediately. If tapping on "OK" is not correct, this is displayed graphically for 2 seconds. After this, the display will return to the "Home" screen again. Try to start the temperature control unit again.

5.1.1.2 Ending the temperature control process

NOTE

When the temperature control unit is switched off, the thermal fluid temperature is higher/lower than room temperature

DAMAGE TO THE TEMPERATURE CONTROL UNIT AND THE GLASS APPARATUS/APPLICATION

- Bring the thermal fluid up to room temperature using the temperature control unit.
- Do not close the shut-off valves in the thermal fluid circuit.

The temperature control can be ended at any time, the pump continues to run for approx. 30 seconds. The compressor is switched off after the stepper motor valve has reached a defined position to control the cold output.

PROCEDURE

- Go to the "Home" screen.
- Tap on the "Stop" touchbutton.
- Confirm the stop of temperature control by tapping on "OK".
The correct selection will be displayed graphically and temperature control will stop immediately and the pump with overrun for about 30 seconds. Wait until the pump stops. If tapping on "OK" is not correct, this is displayed graphically for 2 seconds. After this, the display will return to the "Home" screen again. Try to stop the temperature control unit again.

INFORMATION

The compressor is not switched off until the stepper motor valve has reached a defined position. The status line [Field 10] displays the relevant information.

5.1.2 Temperature control via a created temperature control program

5.1.2.1 Starting the temperature control program

A temperature control program can be started after filling and complete venting.

PROCEDURE

- Go to the “Categories Menu”.
- Tap on the category “Programmer/Ramp”.
- Tap on the category “Start/stop Program”.
- Tap on the dialog entry of the temperature control program to be started.
- Confirm your choice by tapping on “OK”.
- Read the message and confirm it. You temperature control unit will start the temperature control program and the temperature control programmed in it will start.
- Read the Note and confirm by tapping on “OK”.

5.1.2.2 Ending/cancelling the temperature control program

NOTE

When the temperature control unit is switched off, the thermal fluid temperature is higher/lower than room temperature

DAMAGE TO THE TEMPERATURE CONTROL UNIT AND THE GLASS APPARATUS/APPLICATION

- Bring the thermal fluid up to room temperature using the temperature control unit.
- Do not close the shut-off valves in the thermal fluid circuit.

You can either end the temperature control automatically using the parameters predefined in the temperature control program or end/interrupt the temperature control at any time manually. The temperature control is switched off immediately after, the pump continues to run for approx. 30 seconds. The compressor is switched off after the stepper motor valve has reached a defined position to control the cold output.

Manual ending/cancelling

PROCEDURE

- Go to the “Home” screen.
- Tap on the “Stop” touchbutton.
- Confirm the stop of temperature control by tapping on “OK”.
The correct selection will be displayed graphically and temperature control will stop immediately and the pump with overrun for about 30 seconds. Wait until the pump stops. If tapping on “OK” is not correct, this is displayed graphically for 2 seconds. After this, the display will return to the “Home” screen again. Try to stop the temperature control unit again.

INFORMATION

The compressor is not switched off until the stepper motor valve has reached a defined position. The status line [Field 10] displays the relevant information.

5.1.3 Temperature control via beer force ageing test program

5.1.3.1 Start beer force ageing test

A temperature control program can be started after filling and complete venting. Two beer force ageing test programs are already stored in the Pilot ONE. The first program includes: Step 1: +60 °C for 24 hours; Step 2: 0 °C for 24 hours; Number of cycles: 6. The second program includes: Step 1: +40 °C for 24 hours; Step 2: 0 °C for 24 hours; Number of cycles: 6.

PROCEDURE

- Go to the “Categories Menu”.
- Tap on the category “Programmer/Ramp”.
- Tap on the category “Start/stop Program”.
- Tap on the dialog entry of the temperature control program to be started.

- Confirm your choice by tapping on "OK".
- Read the message and confirm it. Your temperature control unit will start the temperature control program and the temperature control programmed in it will start.
- Read the Note and confirm by tapping on "OK".

5.1.3.2 Stop/cancel beer force ageing test program

NOTE

When the temperature control unit is switched off, the thermal fluid temperature is higher/lower than room temperature

DAMAGE TO THE TEMPERATURE CONTROL UNIT AND THE GLASS APPARATUS/APPLICATION

- Bring the thermal fluid up to room temperature using the temperature control unit.
- Do not close the shut-off valves in the thermal fluid circuit.

You can either end the temperature control automatically using the parameters predefined in the temperature control program or end/interrupt the temperature control at any time manually. The temperature control is switched off immediately after, the pump continues to run for approx. 30 seconds. The compressor is switched off after the stepper motor valve has reached a defined position to control the cold output.

Manual ending/cancelling

PROCEDURE

- Go to the "Home" screen.
- Tap on the "Stop" touchbutton.
- Confirm the stop of temperature control by tapping on "OK".
The correct selection will be displayed graphically and temperature control will stop immediately and the pump with overrun for about 30 seconds. Wait until the pump stops. If tapping on "OK" is not correct, this is displayed graphically for 2 seconds. After this, the display will return to the "Home" screen again. Try to stop the temperature control unit again.

INFORMATION

The compressor is not switched off until the stepper motor valve has reached a defined position. The status line [Field 10] displays the relevant information.

6 Interfaces and software update

NOTE

The specifications of the interface used are not being met.

PROPERTY DAMAGE

- Only connect components that meet the specifications of the interface used.

INFORMATION

The use of PB commands is described in our “Data communications PB” manual. This manual can be downloaded from www.huber-online.com.

6.1 Interfaces at the “Pilot ONE®” controller

NOTE

The Pilot ONE controller is not operated behind a firewall

PROPERTY DAMAGE

- Operate the controller Pilot ONE exclusively behind a firewall, if the local subnet is connected to the Internet or another risk-prone network.
- The best available technology is to be applied in order to provide sufficient security for the LAN!

Standard interfaces at the “Pilot ONE” top side

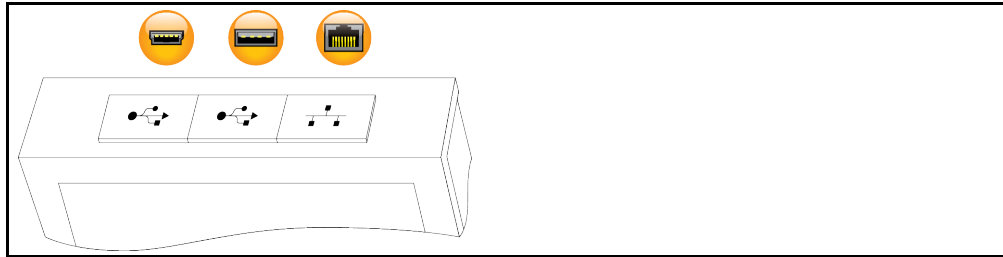

6.1.1 10/100 Mbps Ethernet for RJ45 network sockets



This is a fast and flexible interface. Standard 10/100 Mbps interface (Fast Ethernet), can be connected to any existing Ethernet network. Because this interface can also be connected to very large networks, the IT “Best Practices” (firewall) must be observed.

Usage:

Also - to be able to communicate with the “Pilot ONE” controller - the communication enable must be issued. This is an additional safety feature that prevents persons - possibly unintentionally - connecting to the wrong machine and implementing incorrect temperature control specifications. The following restrictions are possible:

- Deactivated
- Always on (PLC)
- 12h Inactivity Timer
- 10min Inactivity Timer

If, for example, “10min Inactivity Timer” is selected, the connection must be made within 10 minutes after confirmation at the control. If this does not happen, the connection is refused.

INFORMATION

Communication with the Pilot ONE is via TCP (Transmission Control Protocol), Port 8101. The interfaces used must meet the specifications of the generally accepted standards.

6.1.2 USB-2.0 interface

INFORMATION

The interfaces used must meet the specifications of the generally accepted standards.

6.1.2.1 USB-2.0 interface, host



USB-2.0 connection (for connector A), e.g. for data memories.

6.1.2.2 USB-2.0 interface, device



USB-2.0 connection (for Mini-B connector) for communicating with a computer.

6.2 Interfaces at the back

Standard interfaces at the back

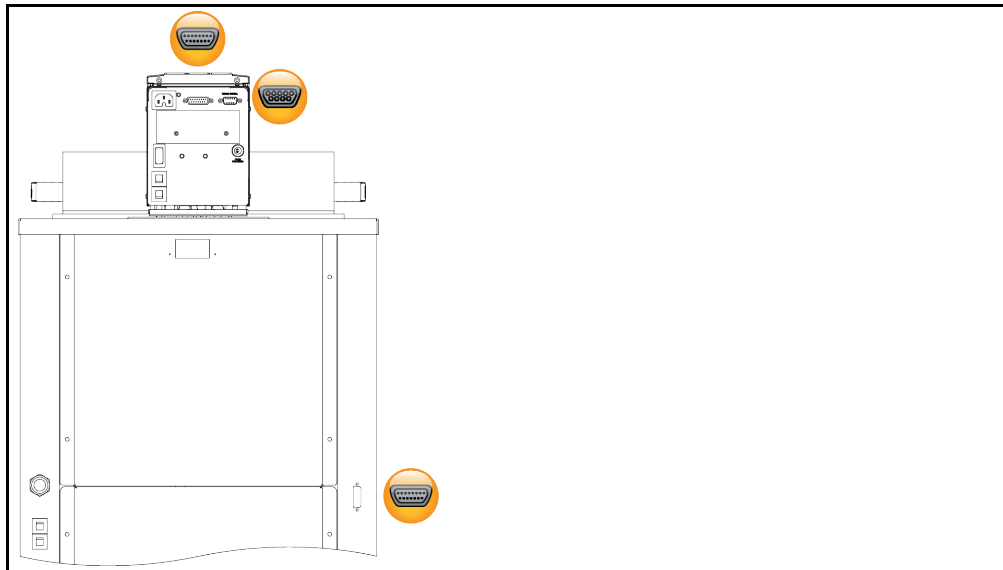

6.2.1 Service interface



This interface is exclusively used by Huber service engineers for service purposes. An adapter cable makes this interface a RS232 serial port.

6.2.2 RS232 (option) / activation of cooling bath



This connector is used to connect the hanger thermostat with the cooling bath. This enables control of the cooling bath via the hanger thermostat.

6.3 Firmware update

An instruction for running a firmware update can be found at www.huber-online.com.

7 Service/maintenance

7.1 Messages from the temperature control unit

Messages output by the temperature control unit can be divided into various classes.

Follow the instructions displayed on the >Touchscreen< [88]. Once a message has been acknowledged, a symbol is output on the >Touchscreen< [88]. Tapping the symbol takes you to an overview of all messages in chronological order.

Displayed symbol: 

7.2 Electrical fuse

The overcurrent circuit breakers for all pole breaking (L and N) are located at the back of the immersion circulator thermostat and temperature control unit. For the exact position please refer to the wiring diagram. → From page 71, section »Annex«. In case of a fault (no function and no display on the immersion circulator thermostat) please first check if the overcurrent circuit breakers have tripped. If the overcurrent circuit breakers trip again immediately after reversing, please unplug the power cord and contact Customer Support immediately. → Page 70, section »Contact data«.

7.3 Replacing the “Pilot ONE®”



Replacing the electronics while the temperature control unit is operating

MORTAL DANGER FROM FIRE

- Stop an ongoing temperature control process.
- Turn off the temperature control unit.
- Also disconnect the temperature control unit from the power supply.

In case of fault, you can replace the “Pilot ONE” yourself. If you have questions or difficulties, please contact your dealer, your local office or our Customer Support.

Replacing the
“Pilot ONE”

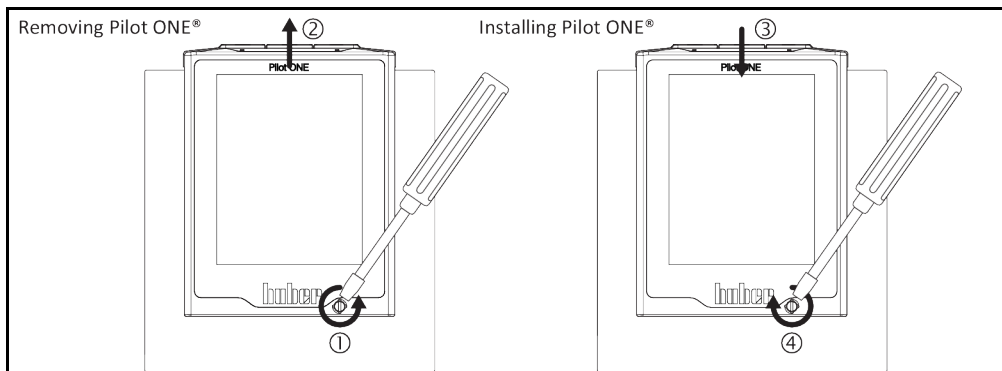

PROCEDURE

- Turn off the temperature control unit.
- Disconnect the temperature control unit from the power supply.
- Release the >Fixing screw for Pilot ONE< [89] at the front of the housing.
- Carefully pull the “Pilot ONE” away upwards.
- Carefully insert the replacement “Pilot ONE”.
- Close the >Fixing screw for Pilot ONE< [89] at the front of the housing.
- Connect the temperature control unit to the power supply.
- Turn on the temperature control unit.

7.4 Maintenance



Cleaning/maintenance while the temperature control unit is operating

MORTAL DANGER FROM ELECTRIC SHOCK

- Stop an ongoing temperature control process.
- Turn off the temperature control unit.
- Also disconnect the temperature control unit from the power supply.



Performing maintenance work not described in these operation manual

MATERIAL DAMAGE ON THE TEMPERATURE CONTROL UNIT

- Please contact Huber for maintenance work that is not described in these operation manual.
- Maintenance work not described in these operation manual is reserved for qualified specialists trained by Huber.
- Safety-relevant components may only be replaced by equivalent ones. The specified safety values for the respective component must be observed.

7.4.1 Function check and visual inspection

Control intervals

Cooling*	Description	Maintenance interval	Comment	Person responsible
A/W	Visually inspect hoses and hose connections	Prior to switching on the temperature control unit	Exchange leaking hoses and hose connections prior to switching on the temperature control unit. → Page 62, section » Replacing coolant hoses «.	Operating company and/or operators
A/W	Inspection in accordance with the F-Gas Directive	In accordance with the F-Gas Directive	→ Page 17, section » Temperature control units with fluorinated greenhouse gases/refrigerants «.	Operating company
A/W	Check the power cable	Prior to switching on the temperature control unit or on relocation	Do not start the temperature control unit if the power cable is damaged.	Qualified electrician (BGV A3)
A	Clean the perforated sheet	As required	Clean the perforated sheet of the temperature control unit with a damp cloth	Operating company
A/W	Thermal fluid inspection	As required	–	Operating company and/or operators
A	Check the liquefier fins	As required, after 3 months at the latest	→ Page 62, section » Clean liquefier fins (air-cooled temperature control unit) «.	Operating company and/or operators
W	Check the hat-type strainer (dirt trap)	As required, after 3 months at the latest	→ Page 63, section » Clean hat-type strainer (dirt trap) (water-cooled temperature control unit) «.	Operating company and/or operators
A/W	Overtemperature protection (OT) - functional check	Every month or after changing the thermal fluid	→ Page 43, section » Testing overtemperature protection for functionality «.	Operating company and/or operators
A/W	Check the temperature control unit for damage and stability	Every 12 months or after a change of location	–	Operating company and/or operators

Cooling*	Description	Maintenance interval	Comment	Person responsible
W	Check the cooling water quality	Every 12 months	Descale the cooling water circuit as required. Documentation on water quality is available at: www.huber-online.com	Operating company and/or operators
A/W	Exchange safety-relevant electric and electromechanical components	20 years	Have the exchange only carried out by certified personnel (such as Huber service engineers). Please contact Customer Support. → Page 70, section »Contact data«.	Operating company

*A = Air cooling; W = Water cooling; U = Applicable only for Unistats

7.4.2 Replacing coolant hoses

Replace defective coolant hoses **before** turning on the temperature control unit.

PROCEDURE

- Drain the cooling water. → Page 68, section »Draining the cooling water«.
- Replace the defective coolant hoses. Follow the instructions for the proper disposal. → Page 15, section »Proper disposal of resources and consumables«.
- Reconnect the temperature control unit to the building's cooling water supply. → Page 26, section »Temperature control units with water cooling«.
- Restart the temperature control unit in normal mode.

7.4.3 Clean liquefier fins (air-cooled temperature control unit)

CAUTION

Manual cleaning

RISK OF BEING CUT ON THE LIQUEFIER FINS

- Wear suitable cut-resistant gloves for cleaning work.
- Depending on the ambient conditions, use cleaning equipment such as vacuum cleaners and/or a hand brush/brush. Follow the local regulations when cleaning. Do not clean the liquefier fins in a clean room with items like a brush and do not use a vacuum cleaner without an extra-fine particle filter.

NOTE

Cleaning using pointed or sharp-edged tools

DAMAGE TO THE LIQUEFIER FINS

- Clean the liquefier fins using suitable cleaning appliances.

INFORMATION

Make sure there is adequate ventilation (removal of waste heat, fresh air supply) for the temperature control unit, in case of **air cooling, maintain wall clearance**. → Page 23, section »Ambient conditions«.

The liquefier fins must be cleaned (dust) from time to time as only then will the temperature control unit perform at its maximum cooling capacity.

Identify the position of the ventilation grille, usually located on the front. With some temperature control units, the ventilation grilles on the side wall, rear or on the underside (table units) of the temperature control unit.

PROCEDURE

Ventilation grille on the front/rear or on a side wall

- Turn off the temperature control unit.
- Disconnect the temperature control unit from the power supply.
- Remove the ventilation grille to create unhindered access to the liquefier fins.
- Clean the liquefier fins using suitable cleaning appliances. Observe the local regulations and ambient conditions when selecting cleaning appliances.

- Make sure the liquefier fins are not damaged or deformed as this will impair the air flow.
- Re-mount the ventilation grille after cleaning work.
- Connect the temperature control unit to the power supply.
- Turn on the temperature control unit.

7.4.4 Clean hat-type strainer (dirt trap) (water-cooled temperature control unit)

NOTE

Building's isolating valves are not closed

DAMAGE BY FLOODING OF ROOMS

- Close the building-side isolating valves of the cooling water supply and return line.
- For table-top models, place a collection container below the **>Cooling water drain<** [15]. Observe the wiring diagram: → From page 71, section **»Annex«**.

INFORMATION

The strainer at the cooling water inlet must be inspected and cleaned on a regular basis, depending on water quality.

PROCEDURE

Table-top models:

- Turn off the temperature control unit.
- Disconnect the temperature control unit from the power supply.
- Close the customer's isolating valves in the cooling water supply and return lines.
- Place a collecting container below the **>Cooling water inlet<** [13].
- Remove the cooling water supply line and take out the hat-type strainer for inspection and cleaning.
- Clean the hat-type strainer under running water.
- Following inspection/cleaning, reinsert the hat-type strainer and fasten the cooling water supply line.
- Remove the collecting container from below the **>Cooling water inlet<** [13].
- Open the customer's isolating valves in the cooling water supply and return lines.
- Connect the temperature control unit to the power supply.
- Switch on the temperature control unit.

INFORMATION

We are also happy to offer you service training. Please contact Customer Support. → Page 70, section **»Contact data«**.

7.5 Thermal fluid inspection, replacement and circuit cleaning

Observe the wiring diagram. → From page 71, section **»Annex«**.

CAUTION

Extremely hot / cold surfaces, connections and thermal fluids

BURNS/FREEZING OF LIMBS

- Surfaces, connections and tempered thermal fluids can be extremely hot or cold depending on the operating mode.
- Avoid direct contact with surfaces, connections and thermal fluids!
- Wear your personnel protective equipment (e.g. temperature-resistant safety gloves, safety goggles).

7.5.1 Thermal fluid inspection

CAUTION

Thermal fluid is not inspected on a regular basis

BURNS DUE TO REDUCED BOILING POINT

- Regularly check your thermal fluid whether it meets the specifications in the safety data sheet.

NOTE

Thermal fluid is not inspected on a regular basis

DAMAGE TO THE HEAT EXCHANGER AND/OR ELECTROMECHANICAL PARTS.

- Regularly check your thermal fluid whether it meets the specifications in the safety data sheet.

INFORMATION

Oxidation

Oxidation ages the thermal fluid and change its characteristics (e.g. a reduced boiling point). When controlling high temperatures, a reduced boiling point may cause overflow of very hot thermal fluids. It may cause serious burns of the limbs.

Hygroscopy

When continuously thermoregulating below room temperature, hygroscopy causes the thermal fluid to accumulate water in the course of time. Such a liquid mixture causes the evaporator to burst when thermoregulating in the minus range. This is caused by the water in the liquid mixture, which forms ice crystals on the evaporator. When thermoregulating high temperatures with such a liquid mixture, the boiling point is reduced. When controlling high temperatures, a reduced boiling point may cause overflow of very hot thermal fluids. It may cause serious burns of the limbs. Hygroscopy can change the mixing ratio of a water-ethylene-glycol mixture.

7.5.2 Rinsing the thermal fluid circuit

DANGER

Setpoint and overtemperature protection are not adjusted to the thermofluid

MORTAL DANGER FROM FIRE

- The cut-out value of the overtemperature protection **must** be adapted to the thermofluid. Set the cut-out value of the overtemperature protection 25 K below the fire point of the thermofluid.
- The setpoint set during rinsing **must** be adjusted to the thermofluid used.

CAUTION

Non-compliance with the safety data sheet for the thermal fluid to be used

INJURIES

- Risk of injury to the eyes, skin, respiratory tract.
- The safety data sheet for the thermal fluid to be used must be read prior to using it and its content must be respected.
- Observe the local regulations/work instructions.
- Wear your personal protective equipment (e.g. temperature-resistant safety gloves, safety goggles, safety footwear).
- Danger of slipping because floor and work area are contaminated. Clean the workplace; observe the proper disposal of thermal fluid and aids. → Page 15, section »**Proper disposal of resources and consumables**«.

NOTE

Mixing different thermofluids in a thermal fluid circuit

PROPERTY DAMAGE

- Do **not** mix different types of thermofluid (such as mineral oil, silicone oil, synthetic oil, water, etc.) in a thermofluid circuit.
- The thermal fluid circuit **must** be rinsed when changing from one type of thermal fluid to another. No residues of the previous type of thermal fluid may remain in the thermal fluid circuit.

The inner components of the temperature control unit must be dried out Need to avoid boiling retardation during future uses (e.g. use of a silicone oil at temperatures above about 100 °C).

PROCEDURE

- Drain the temperature control unit. → Page 54, section »**Draining the bath thermostat**«.

INFORMATION

Residual thermal fluid can remain in the pump chamber and the internal lines after draining. Leave the temperature control unit with open valves for a while.

- Check the level in the collecting container. Follow the instructions for the proper disposal of thermal fluid. → Page 15, section »**Proper disposal of resources and consumables**«.
- Close the >Drain< [8].
- **Fill** the system (minimum fill level) with the thermal fluid you wish to use. → Page 53, section »**Filling of bath thermostat**«.
- Adjust the **setpoint** and the cut-out value of the **Overtemperature protection** to the thermal fluid used. → Page 52, section »**Setting the setpoint**« and → Page 42, section »**Setting the overtemperature protection**«.
- Go to the "Categories Menu".
- Tap on the category "Temperature Control".

- Tap on the category "Start/Stop".
- Tap on the dialog entry "Start temperature control".
- Touch "OK" to confirm your selection. The length of rinsing depends on the level of soiling.
- Tap on the category "Start/Stop".
- Tap on the dialog entry "Stop temperature control".
- Touch "OK" to confirm your selection. The temperature control process is stopped.
- **Drain** the temperature control unit. → Page 54, section »**Draining the bath thermostat**«.
- Repeat the steps "Filling", "Start/Stop temperature control process" and "Draining" until the drained thermal fluid remains clear.
- Leave the >Drain< [8] open for a while to allow the thermal fluid remaining in the temperature control unit to evaporate.
- Close the >Drain< [8] once the residual thermal fluid has evaporated.
- Remove the collecting container.
- Discard the collecting container, including its contents, properly. Follow the instructions for the proper disposal of thermal fluid. → Page 15, section »**Proper disposal of resources and consumables**«.
- Fill the temperature control unit with thermal fluid. → Page 53, section »**Filling of bath thermostat**«.
- Restart the temperature control unit in normal mode.

7.6 Cleaning the surfaces

CAUTION

Extremely hot / cold surfaces, connections and thermal fluids

BURNS/FREEZING OF LIMBS

- Surfaces, connections and tempered thermal fluids can be extremely hot or cold depending on the operating mode.
- Avoid direct contact with surfaces, connections and thermal fluids!
- Wear your personnel protective equipment (e.g. temperature-resistant safety gloves, safety goggles).

NOTE

Exposed plug contacts

DAMAGE CAUSED BY FLUID INGRESS

- Protect unused plug contacts with the protective caps supplied.
- Clean surfaces only with a damp cloth.

A standard stainless steel cleaning agent is suitable for cleaning the stainless steel surfaces. Carefully clean painted surfaces (damp only) using a solution of sensitive-fabrics detergent. Observe the proper disposal of thermal fluid and aids. → Page 15, section »**Proper disposal of resources and consumables**«.

7.7 Plug contacts

NOTE

Exposed plug contacts

DAMAGE CAUSED BY FLUID INGRESS

- Protect unused plug contacts with the protective caps supplied.
- Clean surfaces only with a damp cloth.

Protective caps are supplied for all plug contacts. Make sure that any plug contacts not required are protective with the caps.

7.8 Decontamination/repairs

CAUTION

Returning a not decontaminated temperature control unit for repair

PHYSICAL INJURY AND PROPERTY DAMAGE CAUSED BY HAZARDOUS MATERIALS IN OR ON THE TEMPERATURE CONTROL UNIT

- Carry out appropriate decontamination.
- The decontamination process depends on the type and quantity of the materials used.
- Consult the relevant safety data sheet.
- You will find a prepared return receipt at www.huber-online.com.

As the responsible body you are responsible for carrying out decontamination **before** third-party personnel come into contact with the temperature control unit / accessory. Decontamination must be carried out **before** the temperature control unit / accessory is returned for repair or inspection. Attach a clearly visible written notice stating that the temperature control unit / accessory has been decontaminated.

To simplify the process, we have prepared a form for you. This is available for download at www.huber-online.com.

8 Shutting down

8.1 Safety instructions and basic principles

DANGER

Connection/adjustment to the power supply not carried out by an electrician and/or connection to a power socket without protective earth (PE)

MORTAL DANGER FROM ELECTRIC SHOCK

- Have the connection/adjustment to the power supply carried out by an electrician.
- Always connect the temperature control unit to safety sockets (PE).

DANGER

Damaged power cable/power cable connection

MORTAL DANGER FROM ELECTRIC SHOCK

- Do not start up the temperature control unit.
- Isolate the temperature control unit from the power supply.
- Have the power supply cable/power supply connection replaced and inspected by an electrician.
- Do not use a power cable that is longer than **3 m**.

WARNING

Risk of tipping due to unstable temperature control unit

SERIOUS INJURY AND PROPERTY DAMAGE

- Avoid risk of tipping due to unstable temperature control unit.

CAUTION

Non-compliance with the safety data sheet for the thermal fluid to be used

INJURIES

- Risk of injury to the eyes, skin, respiratory tract.
- The safety data sheet for the thermal fluid to be used must be read prior to using it and its content must be respected.
- Observe the local regulations/work instructions.
- Wear your personal protective equipment (e.g. temperature-resistant safety gloves, safety goggles, safety footwear).
- Danger of slipping because floor and work area are contaminated. Clean the workplace; observe the proper disposal of thermal fluid and aids. → Page 15, section »**Proper disposal of resources and consumables**«.

CAUTION

Hot or very cold thermal fluid

SEVERE BURNS/FROSTBITE OF LIMBS

- Before draining, ensure that the thermal fluid has room temperature (20 °C).
- If, at this temperature, the thermal fluid is too viscous to be drained: Control the temperature of the thermal fluid for a few minutes until the viscosity will allow drainage. Never control the temperature of the thermal fluid when the drain is open.
- Danger of burns when draining thermal fluids at temperatures above 20 °C.
- Wear your Personal Protective Equipment for draining.
- Only drain using suitable drainage hose and collecting container. These must be compatible with the thermal fluid and its temperature.

INFORMATION

All safety instructions are important and must be followed accordingly during working operations!

8.2 Switch-off

PROCEDURE

- **Only valid for temperature control units with the function "Drain":**
For the thermal fluid and/or cooling water circuit to be drained completely, the function "Drain" must be activated. In the event of a water-cooled temperature control unit, this function also opens the control valve in the cooling water circuit, depending on the model. Skip the following instructions if the dialog entry "Drain" is not available:
 - Tap in succession "Category menu", "Temperature control", "Start/stop".
 - Tap on the dialog entry: "Drain".
 - Confirm your choice by tapping on "OK".
 - Read the message and confirm by tapping on "OK".
 - Do **not** confirm the subsequent message by tapping on "OK".
- Turn off the temperature control unit.
- Disconnect the temperature control unit from the power supply connection.

8.3 Draining the temperature control unit

PROCEDURE

- Drain the temperature control unit. → From page 53, section »Filling and draining of bath thermostat«.

8.4 Draining the cooling water

INFORMATION

This section must be observed when using water-cooled temperature control units.

8.4.1 Draining process

CAUTION

Pressurized cooling water connections

RISK OF INJURY

- Wear your personnel protective equipment (e.g. safety goggles).
- Carefully open the cooling water connection. Open slowly (1-2 signal edges) and drain the cooling water slowly.

NOTE

Building's isolating valves are not closed

DAMAGE BY FLOODING OF ROOMS

- Close the building-side isolating valves of the cooling water supply and return line.

INFORMATION

Not all temperature control units are equipped with the same combination of connections/drains. Skip the step in the procedure if the listed connection / drain is not available on your temperature control unit.

PROCEDURE

- Close the building-side isolating valves of the cooling water supply and return line.
- Place a collecting container below the >Cooling water inlet< [13].
- Place a collecting container below the >Cooling water outlet< [14].
- Place a collecting container below the >Cooling water drain< [15].
- Close the >Cooling water drain< [15]. The cooling water will begin to drain out.
- Disconnect the >Cooling water outlet< [14] from the building-side water return flow. The cooling water will begin to drain out. Allow all the cooling water to drain out to prevent the risk of freezing during transport and storage!
- Disconnect the >Cooling water inlet< [13] from the building's cooling water supply.
- Close the >Cooling water drain< [15].

8.5 Uninstalling an external application

PROCEDURE

- Disconnect the external application from the temperature control unit.

8.6 Packing

Always use the original packaging! → Page 23, section »Unpacking«.

8.7 Shipping

NOTE

Temperature control unit transported in a horizontal position
DAMAGE TO THE COMPRESSOR

- Only transport the temperature control unit in an upright position.

NOTE

Temperature control unit transported incorrectly
PROPERTY DAMAGE

- Do not transport by truck on the castors or feet.
- Comply all requirements in this section to avoid damage to the temperature control unit.

Pallet with squared
timber for free-
standing units

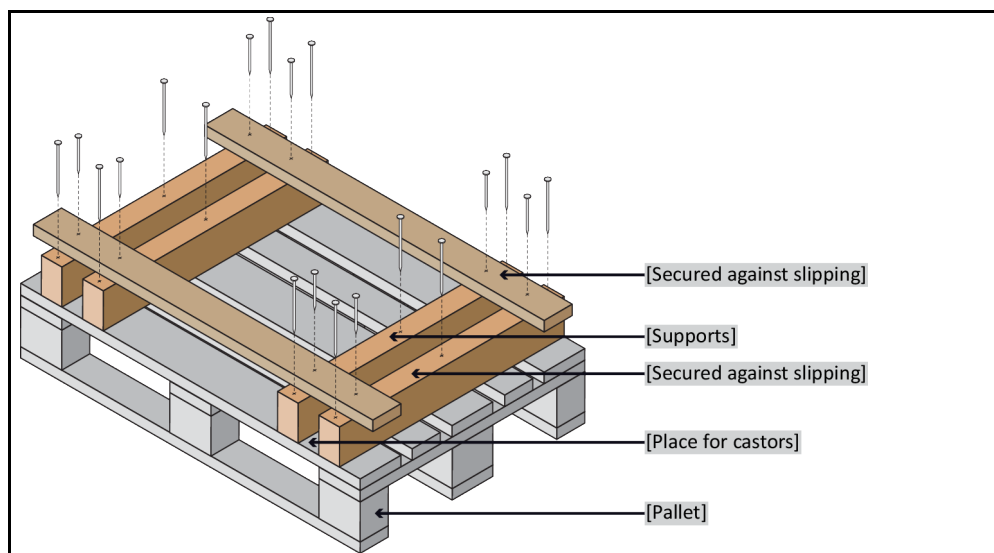

Transport using the lugs, if fitted, on the top of the temperature control unit. Do not transport the temperature control unit alone and without aids.

- Always use the original packaging for transportation.
- Indicate the upright transport position with arrows on the packaging.
- Always transport the temperature control unit upright on a pallet!
- Protect attachments from damage during transportation!
- During transport, place the temperature control unit on squared timber to protect the casters/feet.
- Secure with tensioning belts/lashing straps that are suitable for the weight.
- Additionally secure (depending on model) with plastic film, cardboard and straps.

8.8 Disposal

CAUTION

Uncontrolled or incorrect opening of the coolant circuit

RISK OF INJURY AND ENVIRONMENTAL DAMAGE

- Work on the coolant circuit and disposal of the refrigerant must be carried out by approved refrigeration/air-conditioning system contractors.
- Please strictly observe: → Page 17, section »Temperature control units with fluorinated greenhouse gases/refrigerants«.

NOTE

Improper disposal

ENVIRONMENTAL DAMAGE

- Spilled/leaked thermal fluid must be discarded immediately and correctly. → Page 15, section »Proper disposal of resources and consumables«.
- To avoid environmental damage, have “disused” temperature control units disposed of exclusively by approved waste management companies (e.g. refrigeration and air conditioning companies).
- Please strictly observe: → Page 17, section »Temperature control units with fluorinated greenhouse gases/refrigerants«.

Huber temperature control units and Huber accessories are made of high quality, recyclable materials. For example: Stainless steel 1.4301 / 1.4401 (V2A), copper, nickel, FKM, Perbunan, NBR, ceramic, carbon, Al-Oxid, red brass, brass, nickel-plated brass and silver solder. Proper recycling of the temperature control unit and accessories can actively help reduce CO₂ emissions in the production of these materials. Follow the laws and regulations of your jurisdiction when disposing material.

8.9 Contact data

INFORMATION

Contact your supplier or local specialist retailer **prior** to returning the temperature control unit. The contact data can be found on our homepage www.huber-online.com under the heading „Contact“. Please keep the serial number of the temperature control unit ready. The serial number can be found on the nameplate of the temperature control unit.

8.9.1 Telephone number: Customer Support

If your country is not mentioned in the list below: The responsible service partner can be found on our homepage www.huber-online.com under the heading „Contact“.

- Huber Deutschland: +49 781 9603 244
- Huber China: +86 (20) 89001381
- Huber India: +91 80 2364 7966
- Huber Ireland: +44 1773 82 3369
- Huber Italia: +39 0331 181493
- Huber Swiss: +41 (0) 41 854 10 10
- Huber UK: +44 1773 82 3369
- Huber USA: +1 800 726 4877 | +1 919 674 4266

8.9.2 Telephone number: Sales

Telephone: +49-781-9603-123

8.9.3 Email address: Customer Support

Email: support@huber-online.com

8.10 Certificate of Compliance

This certificate must be enclosed with the temperature control unit. → Page 65, section »Decontamination/repairs«.

9 Annex

Inspired by **temperature** designed for you

Peter Huber Kältemaschinenbau SE
Werner-von-Siemens-Str. 1
77656 Offenburg / Germany

Telefon +49 (0)781 9603-0
Telefax +49 (0)781 57211

info@huber-online.com
www.huber-online.com

Technischer Service: +49 (0)781 9603-244

-125 °C ... +425 °C

huber